

# DT6-B927 DT6-B928

パーツブック  
PARTS BOOK  
TEILEKATALOG  
LIVRE DES PIECES  
LIBRO DE REFERENCIA DE PIEZAS

2本針・3本針二重環縫伏縫腕ミシン

TWIN NEEDLE/THREE NEEDLE FEED OF THE ARM DOUBLE CHAIN STITCHER

ZWEINADEL/DRENADEL-DOPPELKETTENSTICH-ARMABWÄRTSMASCHINE

MACHINE BRAS DEPORTE-POINT DE CHAINETTE DOUBLE 2/3 AIGUILLES

MAQUINA DE DOS/TRES AGUJAS DE BRAZO CADENETA

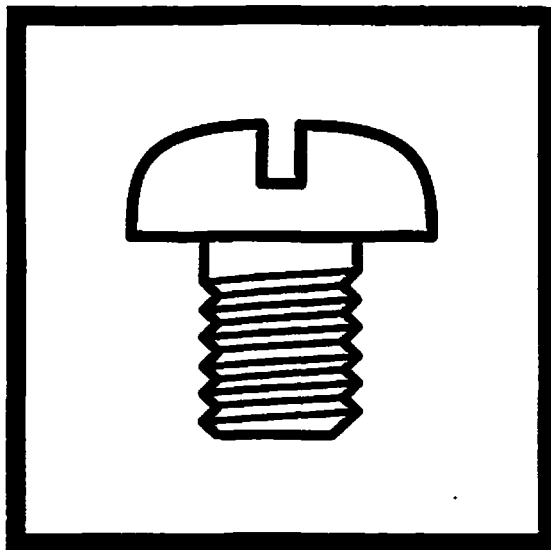

---

**brother.**

From the library of: Superior Sewing Machine & Supply LLC

## Notes sur l'utilisation de ce manuel de pièces détachées

1. Ce manuel a été fait d'après les renseignements valables au mois de Décembre 1996.
2. Les pièces peuvent être sujettes à des modifications sans préavis.
3. Les pièces fournies en tant qu'assemblages complets sont encadrées avec un trait pointillé [-----].
4. Si le symbole ※ se trouve dans la colonne "Parts No. (N° de pièce)" veuillez la vous référer à la LISTE DES PIÈCES ACCESSOIRES page 55~59.

### TABLE DES MATIERES

A . Corps de la machine .....	1	J . Mécanisme de l'arbre inférieur .....	29
B . Mécanisme de l'arbre supérieur .....	1	K . Mécanisme des griffes .....	31
C . Mécanisme de la barre à aiguille .....	3	L1 . Mécanisme de l'enfilage supérieur (B927) .....	33
D1 . Mécanisme du la barra de presser (B927) .....	3	L2 . Mécanisme de l'enfilage supérieur (B928) .....	37
D2 . Mécanisme du la barra de presser (B928) .....	5	M1 . Mécanisme de l'enfilage inférior (B927) .....	41
E . Poulie .....	7	M2 . Mécanisme de l'enfilage inférior (B928) .....	45
F . Mécanisme de l'entraînement .....	9	Z1 . Accessoires .....	49
G1 . Pièces du jauge (B927 Standard) .....	11	Z2 . Accessoires .....	51
G2 . Pièces du jauge (B927 "-7, -8") .....	13	LISTE DES PIÈCES ACCESSOIRES (B927) .....	55
G3 . Pièces du jauge (B928 Standard) .....	15	LISTE DES PIÈCES ACCESSOIRES (B928) .....	57
G4 . Pièces du jauge (B928 "-5") .....	17	PIÈCES EN OPTION (B928) .....	60
G5 . Pièces du jauge (B928 "-6") .....	19	Etiquettes d'avertissement .....	61
G6 . Pièces du jauge (B928 "-7") .....	21	Index .....	62
G7 . Pièces du jauge (B928 "-8") .....	23		
H . Mécanisme due puller (-7, -8) .....	25		

A. 主体関係 / Machine body / Maschinengehäuse / Corps de la machine / Cuerpo de la máquina

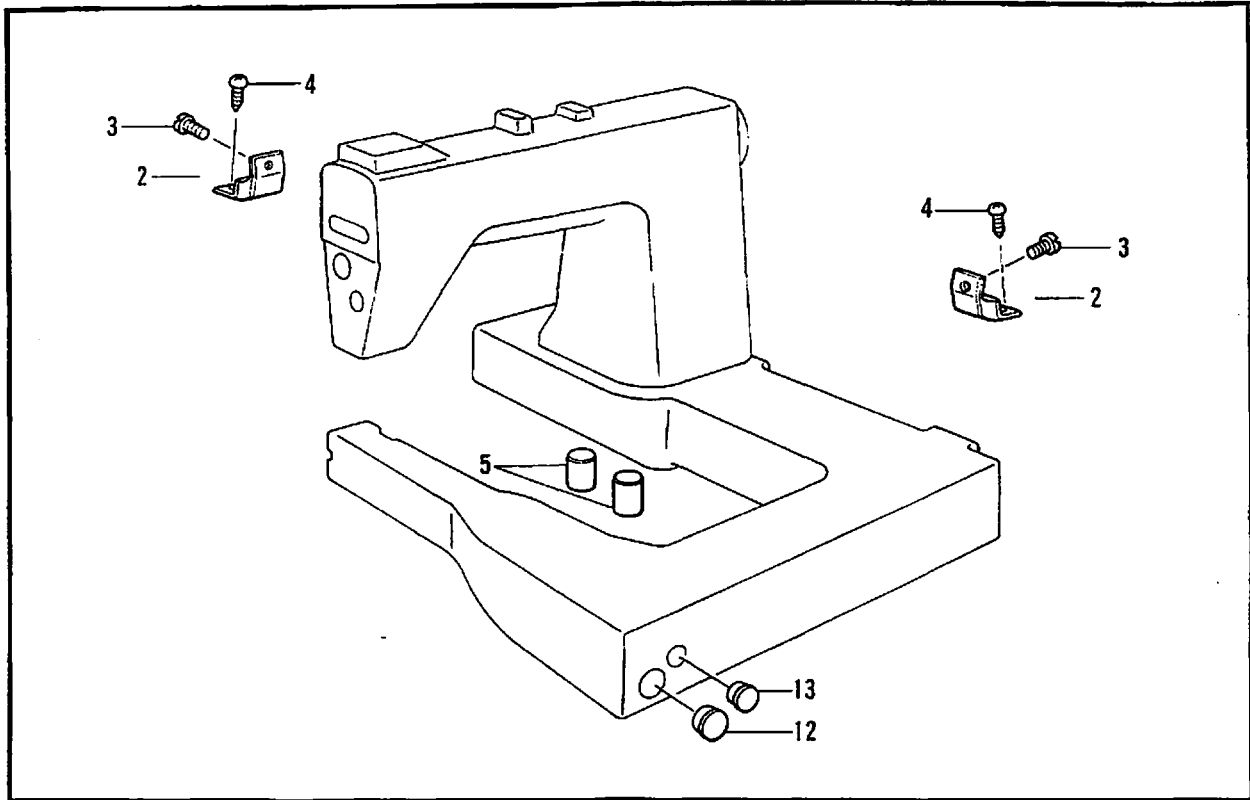

118-927-050

B. 上軸関係 / Upper shaft mechanism / Obere Welle / Mécanisme de l'arbre supérieur / Mecanismo del eje superior

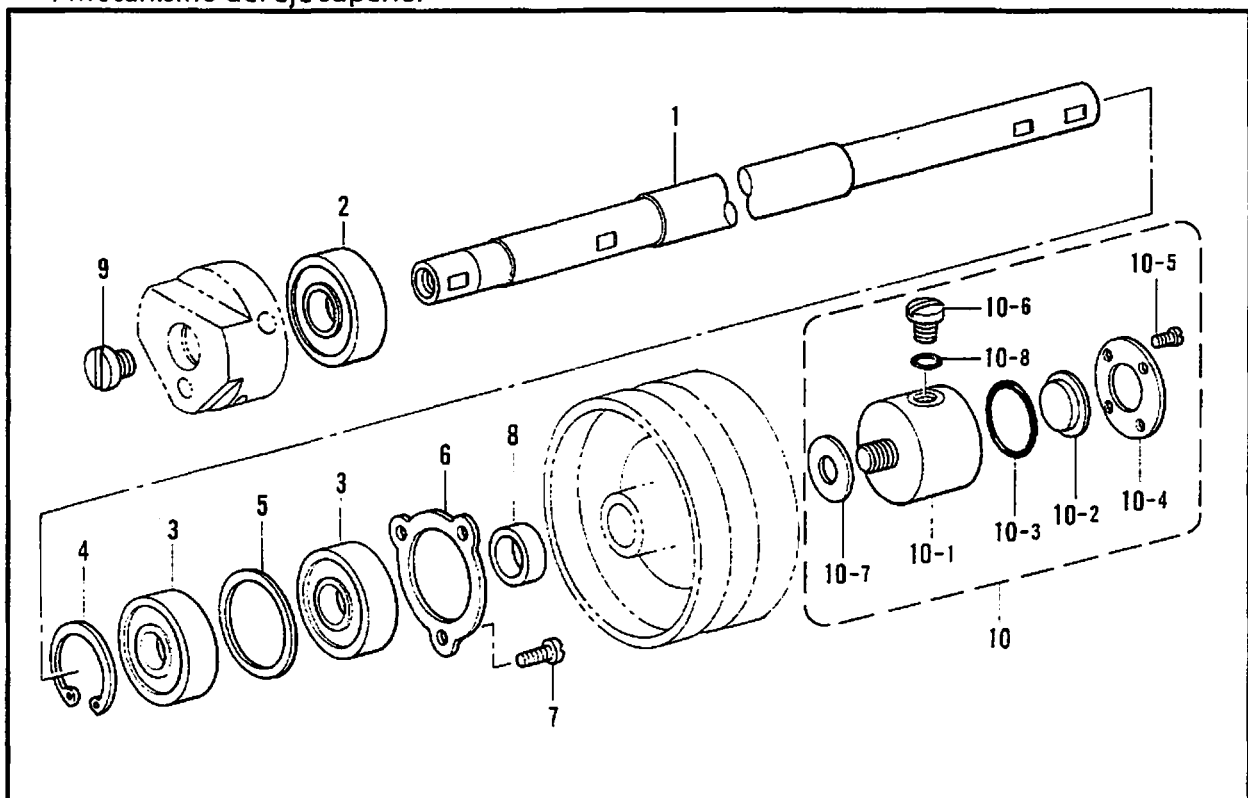

118-927-109

A. 主体関係 / Machine body / Maschinengehäuse / Corps de la machine / Cuerpo de la máquina

REF.NO.	CODE	Q'TY	ヒンメイ	NAME OF PARTS	RM
2	105337001	2	クツシヨンクミ	CUSHION ASSY	
3	105146001	2	シメネジ6.35	SCREW, SM6.35	
4	080622502	2	+マルモク62X25	WOOD SCREW, ROUND M6.2X25	
5	105341051	2	ボウクツシヨン	BASE CUSHION	
12	150697001	1	オイルポツトマド	OIL GAUGE WINDOW	
13	104449009	1	ゴムセン15.5	RUBBER CAP, 15.5	

118-927-050

B. 上軸関係 / Upper shaft mechanism / Obere Welle / Mécanisme de l'arbre supérieur / Mecanismo del eje superior

REF.NO.	CODE	Q'TY	ヒンメイ	NAME OF PARTS	RM
1	S40314001	1	ウワジク	UPPER SHAFT	
2	076302850	1	タマジクウケ6302ZZ	BALL BEARING, 6302ZZ	
3	072630260	2	ベアリング6302VV	BALL BEARING, 6302VV	
4	048420242	1	トメワアナヨウC42	RETAINING RING, C42	
5	S40315051	1	ベアリングスペーサ	BEARING SPACER	
6	S40316051	1	ベアリングオサエ	BEARING PRESSER	
7	062711012	3	ナベコ476-32X10	SCREW, PAN SM4.76-32X10	
8	S40318051	1	ウワジクカラー	UPPER SHAFT COLLAR	
9	S40317001	1	シメネジ9.52	SCREW, SM9.52	
10	S40812001	1	オイルタンククミ	OIL TANK ASSY	
10-1	S40383001	1	オイルタンク	OIL TANK	
10-2	104547001	1	エリヨウケイマド	OIL GAUGE WINDOW	
10-3	081014670	1	OリングPW14	O RING, PW14	
10-4	151074009	1	エリヨウケイフタ	OIL GAUGE COVER	
10-5	100257010	4	シメネジ3.57	SCREW, SM3.57	
10-6	111193001	1	オイルクチフタ	OIL FEEDING PIPE CAP	
10-7	105071001	1	オイルタンクパツキン	OIL TANK PACKING	
10-8	111194001	1	Oリング	O RING	

118-927-109

C. 針棒関係 / Needle bar mechanism / Nadelstangenvorrichtung  
 / Mécanisme de la barre à aiguille / Mecanismo de la barra de aguja

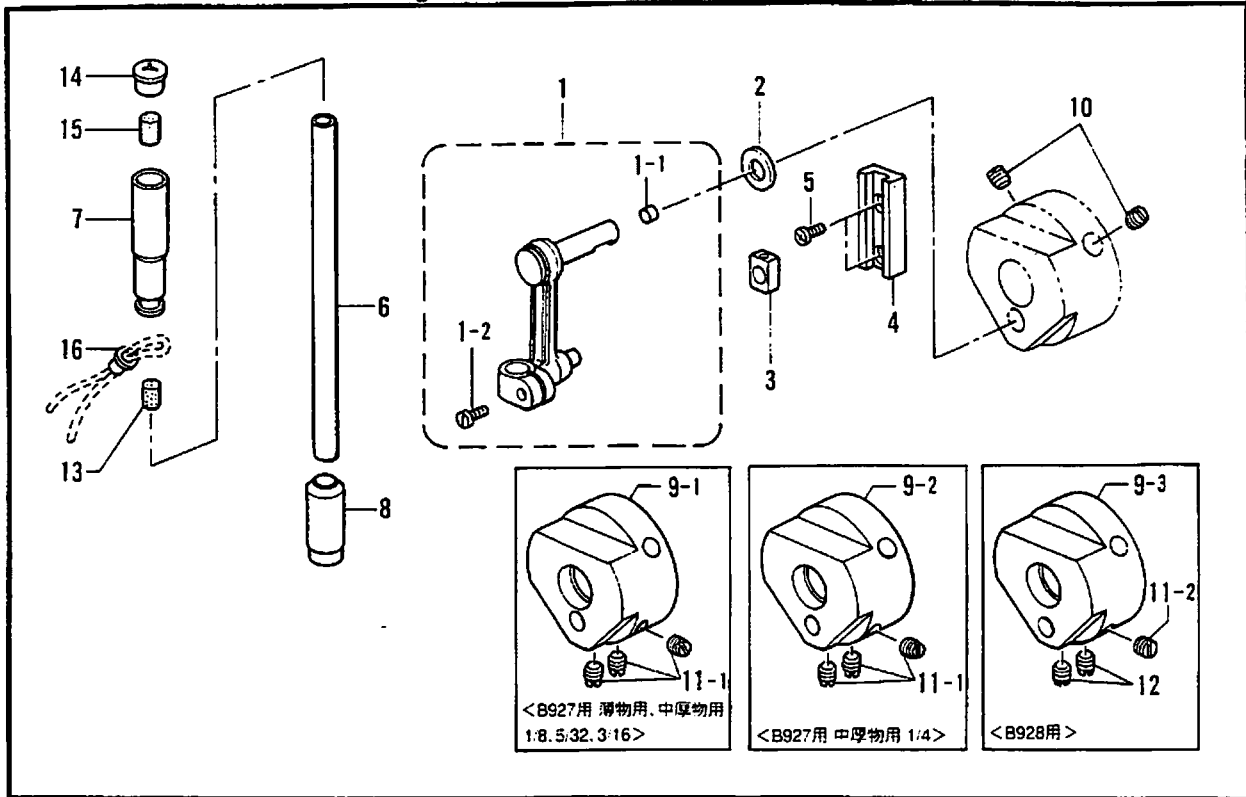

118-927-118

D1. 押し棒関係 (B927) / Presser bar mechanism (B927) / Stoffdrückerstange (B927)  
 / Mécanisme du la barra de presser (B927) / Mecanismo de la barra del prensatelas (B927)

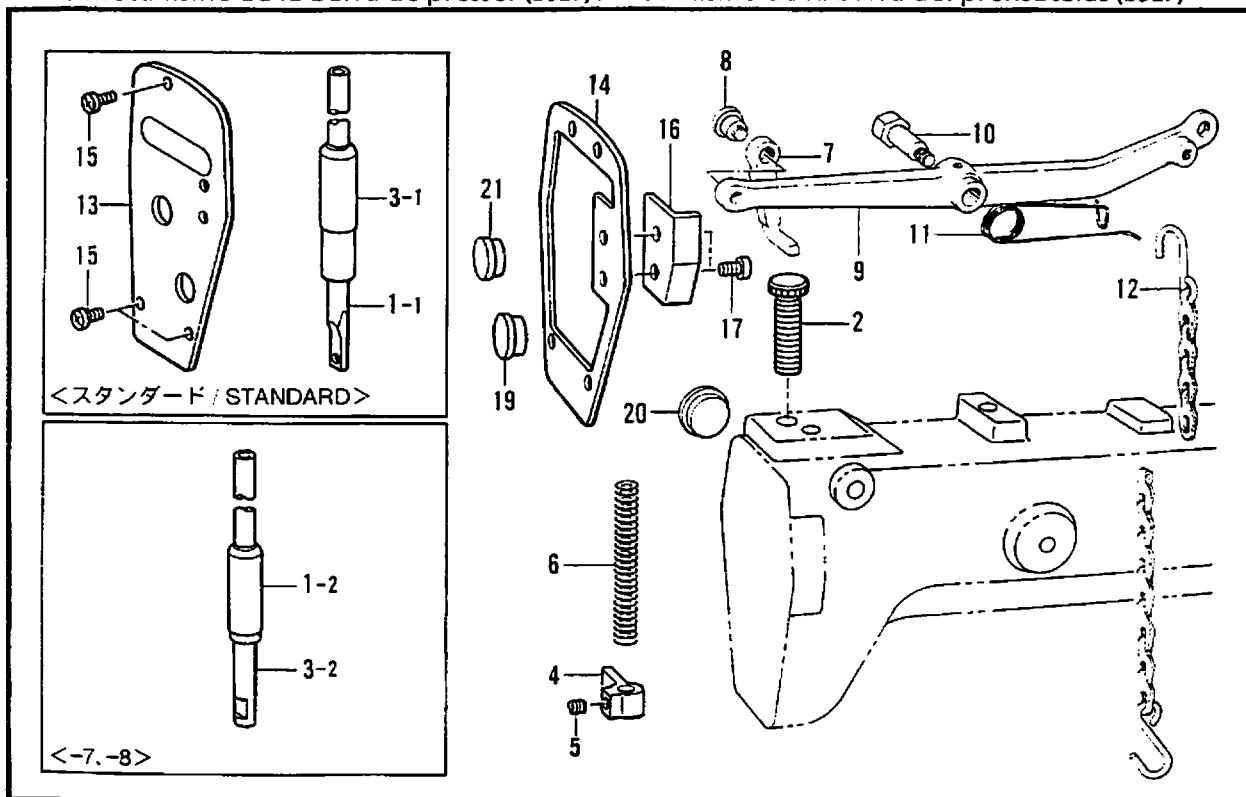

118-927-210

C. 針棒関係 / Needle bar mechanism / Nadelstangenvorrichtung  
/ Mécanisme de la barre à aiguille / Mecanismo de la barra de aguja

REF.NO.	CODE	Q'TY	ヒンメイ	NAME OF PARTS	RM
1	540268001	1	ハリボウレンカンクミ	THREAD TAKE-UP LEVER ASSY	
1-1	142274009	1	ゴムセン4.2	RUBBER CAP, 4.2	
1-2	140004001	1	シメネジ3.57	SCREW, SM3.57	
2	107153001	1	ザガネ	WASHER	
3	102630001	1	ハリボウアンナイカクコマ	NEEDLE BAR GUIDE SLIDE BLOCK	
4	145688000	1	ハリボウアンナイ	NEEDLE BAR GUIDE	
5	062670612	2	ナベコ357-40X6	SCREW, PAN SM3.57-40X6	
6	113605051	1	ハリボウ	NEEDLE BAR	
7	S18874001	1	ハリボウメタルU	NEEDLE BAR BUSH, U	
8	111024101	1	ハリボウメタルD	NEEDLE BAR BUSH, D	
10	014771022	2	アナトメネジ6.35クボミ	SET SCREW, SOCKET (CP) SM6.35	
13	111863001	1	ハリボウセン	NEEDLE BAR CORK	
14	140890009	1	オイルカツフ	OIL CAP	
15	151927001	1	クラツチフェルト	CLUTCH FELT	
16	109993001	1	ハトメ	WICK NIPPER	
-----					
9-1	540271051	1	<B927薄物・中厚物用 1/8, 5/32, 3/16">	<For B927 Thin & Medium materials "1/8, 5/32, 3/16">	
11-1	100251001	3	テンピンクランクM トメネジ6.35	THREAD TAKE-UP CRANK, M SET SCREW, SM6.35	
9-2	540272051	1	<B927 中厚物用 1/4">	<For B927 Medium materials "1/4">	
11-1	100251001	3	テンピンクランクMH トメネジ6.35	THREAD TAKE-UP CRANK, MH SET SCREW, SM6.35	
9-3	540273051	1	<B928用>	<FOR B928>	
11-2	100251001	1	テンピンクランクH	THREAD TAKE-UP CRANK, H	
12	123006001	2	トメネジ6.35クボミ	SET SCREW, (CP) SM6.35	

118-927-118

D1. 押工棒関係 (B927) / Presser bar mechanism (B927) / Stoffdrückérstange (B927)  
/ Mécanisme du la barra de presser (B927) / Mecanismo de la barra del prensatelas (B927)

REF.NO.	CODE	Q'TY	ヒンメイ	NAME OF PARTS	RM
2	540299001	1	オサエチヨウセツネジ	ADJUST SCREW	
4	540798050	1	オサエボウダキ	PRESSER BAR CLAMP	
5	014760622	1	アナトメネジ5.95	SET SCREW, SOCKET SM5.95	
6	540298051	1	オサエバネ	SPRING	
7	105103001	1	オサエボウアゲ	PRESSER BAR LIFTER	
8	105104001	1	ダンネジ5.95	SHOULDER SCREW, SM5.95	
9	105105009	1	ヒザアゲテコ	KNEE LIFTER LEVER	
10	102921002	1	ダンネジ7.94	SHOULDER SCREW, SM7.94	
11	105106001	1	ヒザアゲネジリバネ	TWIST SPRING	
12	105333001	1	クサリアクミ	PRESSER FOOT LIFTER CHAIN ASSY	
14	540301001	1	メンイタハツキン	PACKING	
16	540279001	1	ソクメンイタ	FRONT LID	
17	062680512	2	ナベコ437-40X5	SCREW, PAN SM4.37-40X5	
19	117934009	1	ゴムセン13.5	RUBBER CAP, 13.5	
20	159150009	1	ゴムセン20.5	RUBBER CAP, 20.5	
21	159150009	1	ゴムセン20.5	RUBBER CAP, 20.5	
-----					
1-1	506259001	1	<スタンダード用>	<FOR STANDARD>	
3-1	111025001	1	オサエボウ	PRESSER BAR	
13	540300001	1	オサエボウメタルD	PRESSER BAR BUSH, D	
15	062681012	3	メンイタ ナベコ437-40X10	FACE PLATE SCREW, PAN SM4.37-40X10	
1-2	506261001	1	<-7, -8用>	<FOR "-7, -8">	
3-2	150665001	1	オサエボウ	PRESSER BAR	
		1	オサエボウメタルD	PRESSER BAR BUSH, D	

118-927-210

D2 . 押工棒関係 (B928) / Presser bar mechanism (B928) / Stoffdrückérstange (B928)  
 / Mécanisme du la barra de presser (B928) / Mecanismo de la barra del prensatelas (B928)

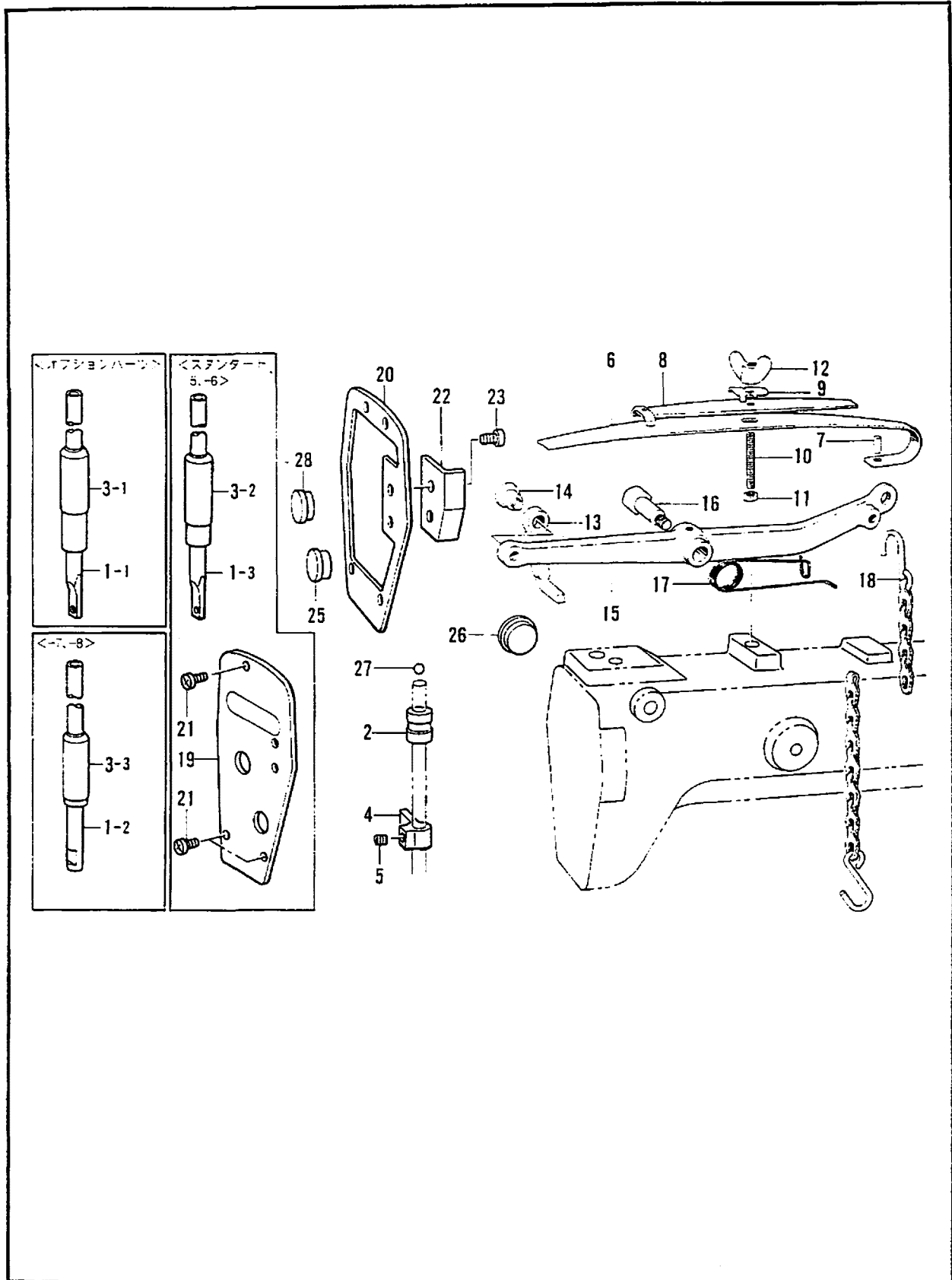

118-928-210

D2. 押工棒関係 (B928) / Presser bar mechanism (B928) / Stoffdrückerstange (B928)  
 / Mécanisme du la barra de presser (B928) / Mecanismo de la barra del prensatelas (B928)

REF.NO.	CODE	Q'TY	ヒンメイ	NAME OF PARTS	RM
2	105091001	1	オサエボウメタルU	PRESSER BAR BUSH, U	
4	540798050	1	オサエボウダキ	PRESSER BAR CLAMP	
5	014760622	1	アナトメネジ5.95	SET SCREW, SOCKET SM5.95	
6	105094009	1	オサエイタバネ	PRESSER PLATE SPRING	
7	105095001	1	オサエイタバネピン	PIN	
8	105096009	1	カサネイタバネクミ	PLATE SPRING ASSY	
9	105100001	1	カサネイタバネトメザガネ	WASHER	
10	148006001	1	オサエチヨウセツネジ	ADJUST SCREW	
11	021710212	1	ナツト2シユ4.76	NUT, 2 SM4.76	
12	148007051	1	チヨウナツト4.76	WING NUT, SM4.76	
13	105103001	1	オサエボウアゲ	PRESSER BAR LIFTER	
14	105104001	1	ダンネジ5.95	SHOULDER SCREW, SM5.95	
15	105105009	1	ヒザアゲテコ	KNEE LIFTER LEVER	
16	102921002	1	ダンネジ7.94	SHOULDER SCREW, SM7.94	
17	105106001	1	ヒザアゲネジリバネ	TWIST SPRING	
18	105333001	1	クサリアクミ	PRESSER FOOT LIFTER CHAIN ASSY	
20	540301001	1	メンイタバツキン	PACKING	
22	540279001	1	ソクメンイタ	FRONT LID	
23	062680512	2	ナベコ437-40X5	SCREW, PAN SM4.37-40X5	
25	117934009	1	ゴムセン13.5	RUBBER CAP, 13.5	
26	159150009	1	ゴムセン20.5	RUBBER CAP, 20.5	
27	071063550	1	コウキユウ1/4	BEARING BALL, 1/4	
28	159150009	1	ゴムセン20.5	RUBBER CAP, 20.5	
1-3	S06260001	1	<スタンダード,-5,-6用> オサエボウ	<FOR STANDARD, -5 & -6> PRESSER BAR	
3-2	147865001	1	オサエボウメタルD	PRESSER BAR BUSH, D	
19	540300001	1	メンイタ	FACE PLATE	
21	062681012	3	ナベコ437-40X10	SCREW, PAN SM4.37-40X10	
1-2	S06261001	1	<-7,-8用> オサエボウ	<FOR "-7,-8"> PRESSER BAR	
3-3	150665001	1	オサエボウメタルD	PRESSER BAR BUSH, D	
1-1	S06259001	1	" オプション部品 " オサエボウ	" OPTION PARTS " PRESSER BAR	
3-1	111025001	1	オサエボウメタルD	PRESSER BAR BUSH, D	

118-928-210



E. プーリ関係 / Pulley mechanism / Gürtelradmechanismus / Poulie / Polea

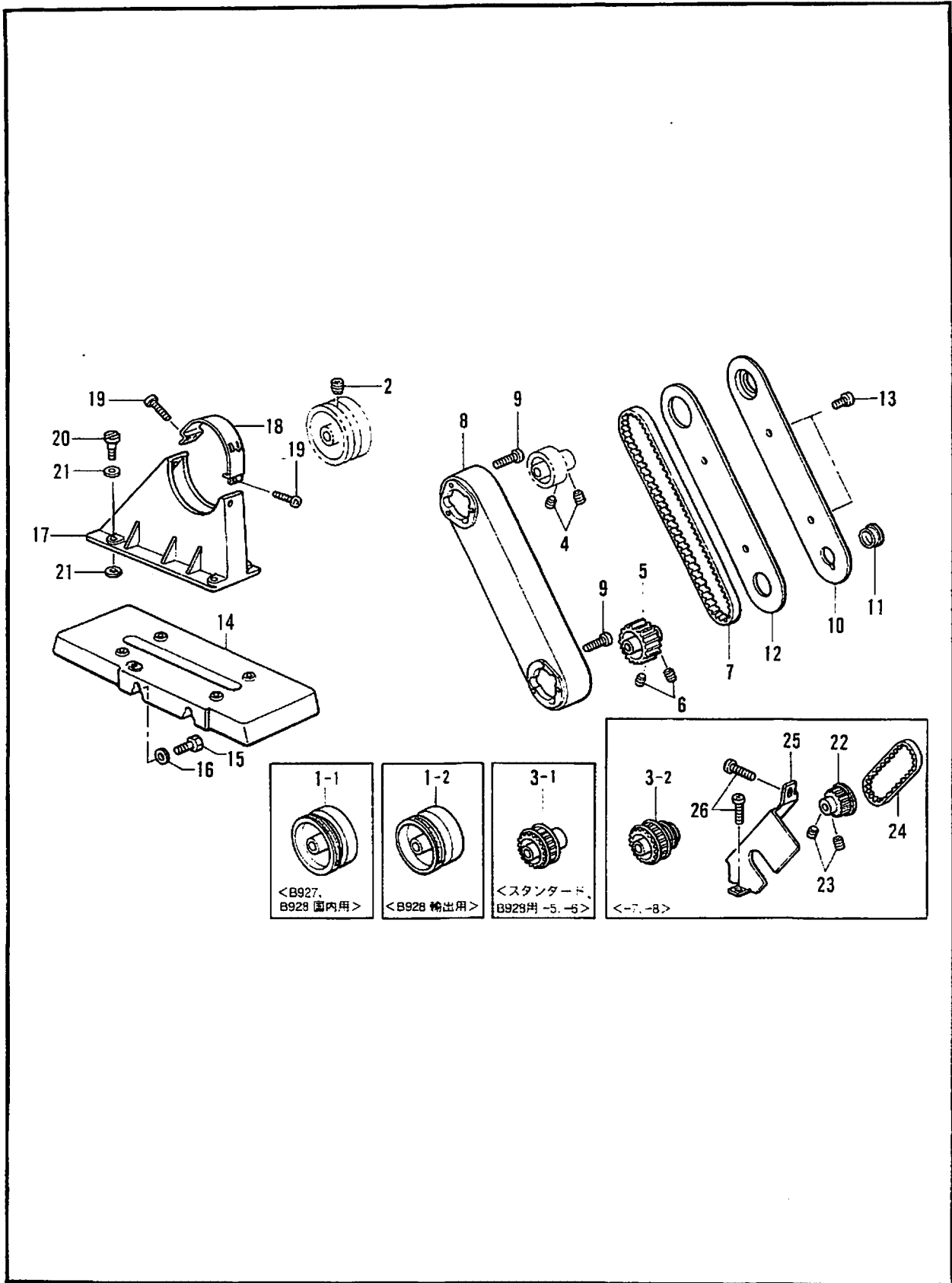

E. プーリ関係 / Pulley mechanism / Gürtelradmechanismus / Poulie / Polea

REF.NO.	CODE	Q'TY	ヒンメイ	NAME OF PARTS	RM
2	014781032	2	アナクボミ 635-28X10	SET SCREW, SOCKET (CP) SM6.35	
4	014770622	2	アナトメネジ 6.35クボミ	SET SCREW, SOCKET (CP) SM6.35	
5	540818001	1	シタベルトクルマ	TIMING BELT WHEEL ASSY, LOWER	
6	014770622	2	アナトメネジ 6.35クボミ	SET SCREW, SOCKET (CP) SM6.35	
7	540819000	1	タイミングベルト	TIMING BELT	
8	540258001	1	ベルトカバー	BELT COVER	
9	062711612	6	ナベコ 476-32X16	SCREW, PAN SM4.76-32X16	
10	540259001	1	ベルトカバーフタ	BELT COVER PLATE	
11	116577051	1	カムジクフタ	ROTARY HOOK SHAFT COVER	
12	105141001	1	ベルトカバーフタハツキン	PACKING	
13	062710812	2	ナベコ 476-32X8	SCREW, PAN SM4.76-32X8	
14	540796001	1	プーリカバーダイ	PULLEY COVER BASE	
15	105144001	2	ボルト 11.11	BOLT, SM11.11	
16	142627001	2	ザガネ	WASHER	
17	540261001	1	プーリカバーA	PULLEY COVER, A	
18	540262001	1	プーリカバーB	PULLEY COVER, B	
19	062680712	3	ナベコ 437-40X7	SCREW, PAN SM4.37-40X7	
20	155558001	4	ダンネジ 6.35	STUD SCREW, SM6.35	
21	540797000	8	プーリカバーシート	PULLEY COVER SHEET	
1-1	540280001	1	<B927用, B928国内用> プーリMクミ	<FOR B927 & B928 Japan> PULLEY ASSY, M	
1-2	540281001	1	<B928輸出用> プーリHクミ	<FOR B928 EXPORT> PULLEY ASSY, H	
3-1	540265001	1	<スタンダード, B928-5, -6用> ウエベルトクルマクミ	<FOR STANDARD, B928-5 & -6> TIMING BELT WHEEL ASSY, UPPER	
3-2	541312001	1	<-7, -8用> プーラウエベルトクルマクミ	<FOR "-7, -8"> PULLER TIMING BELT WH. ASSY, U	
22	150659001	1	タイミングプーリBクミ	TIMING PULLEY ASSY, B	
23	014760622	2	アナトメネジ 5.95	SET SCREW, SOCKET SM5.95	
24	150661001	1	プーラタイミングベルトA	PULLER TIMING BELT, A	
25	540264001	1	プーラベルトカバー	PULLEY BELT COVER	
26	062680812	2	ナベコ 437-40X8	SCREW, PAN SM4.37-40X8	

118-927-120

F. 送り関係 / Feed mechanism / Transportvorrichtung / Mécanisme de l'entraînement / Mecanismo de la alimentación

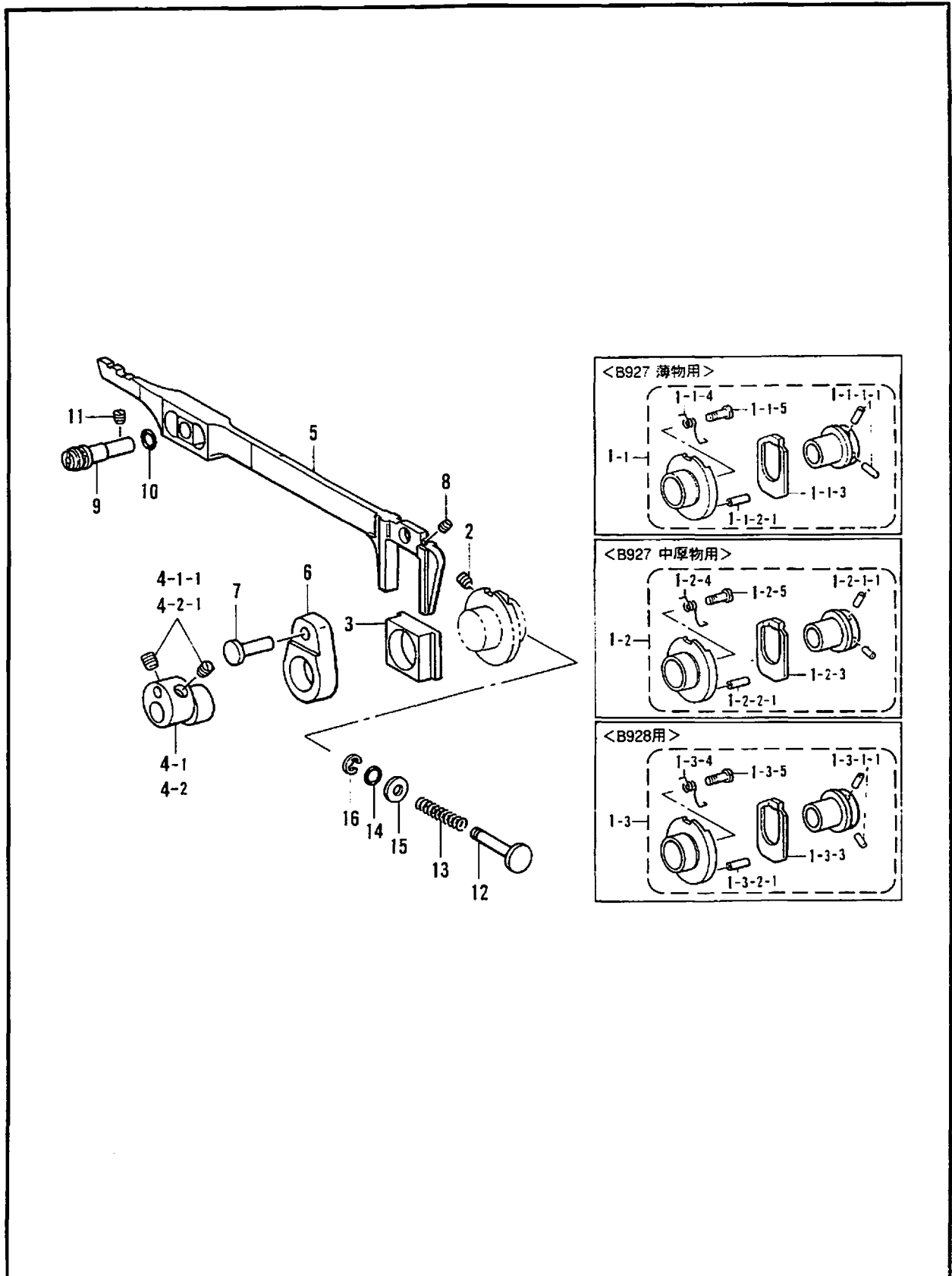

118-927-202

F. 送り関係 / Feed mechanism / Transportvorrichtung / Mécanisme de l'entraînement /  
Mecanismo de la alimentación

REF.NO.	CODE	Q'TY	ヒンメイ	NAME OF PARTS	RM
1-1	S40274001	1	<B927薄物用> ヘンシンリンクミM	<FOR B927 "THIN MATERIALS"> ECCENTRIC WHEEL ASSY, M	
1-1-1-1	047301242	2	スプリングピンAW3	PIN, SPRING AW3	
1-1-2-1	047301242	1	スプリングピンAW3	PIN, SPRING AW3	
1-1-3	S38309001	1	ラチエツトストツバ	RACHTER STOPPER	
1-1-4	S39585001	1	ラチエツトトメネジリバネ	TWIST SPRING	
1-1-5	S39586001	1	バネトメネジ3	SCREW, M3	
1-2	S40274002	1	<B927中厚物用> ヘンシンリンクミM	<FOR B927 "MEDIUM MATERIALS"> ECCENTRIC WHEEL ASSY, M	
1-2-1-1	047301242	2	スプリングピンAW3	PIN, SPRING AW3	
1-2-2-1	047301242	1	スプリングピンAW3	PIN, SPRING AW3	
1-2-3	S38309001	1	ラチエツトストツバ	RACHTER STOPPER	
1-2-4	S39585001	1	ラチエツトトメネジリバネ	TWIST SPRING	
1-2-5	S39586001	1	バネトメネジ3	SCREW, M3	
1-3	S40291001	1	<B928用> ヘンシンリンクミH	<FOR B928> ECCENTRIC WHEEL ASSY, H	
1-3-1-1	047301242	2	スプリングピンAW3	PIN, SPRING AW3	
1-3-2-1	047301242	1	スプリングピンAW3	PIN, SPRING AW3	
1-3-3	S38309001	1	ラチエツトストツバ	RACHTER STOPPER	
1-3-4	S39585001	1	ラチエツトトメネジリバネ	TWIST SPRING	
1-3-5	S39586001	1	バネトメネジ3	SCREW, M3	
4-1	183949001	1	<B927用> ヘンシンリンネジツキM	<FOR B927> ECCENTRIC WHEEL WITH SCREW, M	
4-1-1	014770622	2	アナトメネジ6.35クボミ	SET SCREW, SOCKET (CP) SM6.35	
4-2	183950001	1	<B928用> ヘンシンリンネジツキH	<FOR B928> ECCENTRIC WHEEL WITH SCREW, H	
4-2-1	014770622	2	アナトメネジ6.35クボミ	SET SCREW, SOCKET (CP) SM6.35	
2	012060632	2	アナヒラ6X6	SET SCREW, SOCKET (FT) M6X6	
3	S40282000	1	ヘンシンリンスリーブ	ECCENTRIC WHEEL SLEEVE	
5	S40285001	1	オクリダイカクコマクミ	FEED BAR SLIDE BLOCK ASSY	
6	S40288000	1	ジヨウゲオクリレンカン	FEED LIFTING CONNECTING SHAFT	
7	S40289051	1	ジヨウゲオクリジク	FEED LIFTING ROCK SHAFT	
8	014760622	1	アナトメネジ5.95	SET SCREW, SOCKET SM5.95	
9	S41311051	1	オクリダイヘンシンジク	FEED BAR ECCENTRIC SHAFT	
10	081006070	1	OリングP6	O RING, P6	
11	014761030	1	アナクボミ595-28X10	SET SCREW, SOCKET (CP) SM5.95	
12	S40290051	1	プツシュボタン	PUSH BUTTON	
13	S40800001	1	ボタンジクバネ	SPRING	
14	081005070	1	OリングP5	O RING, P5	
15	025710132	1	ヒラザガネシヨウ4.76	WASHER, PLAIN S 4.76	
16	048040342	1	トメフE4	RETAINING RING, E4	

118-927-202

G1. ゲージ関係 (B927スタンダード) / Gauge parts (B927 Standard) / Lehren (B927 Norm)  
 / Pièces du jauge (B927 Standard) / Piezas de calibradores (B927 Norma)

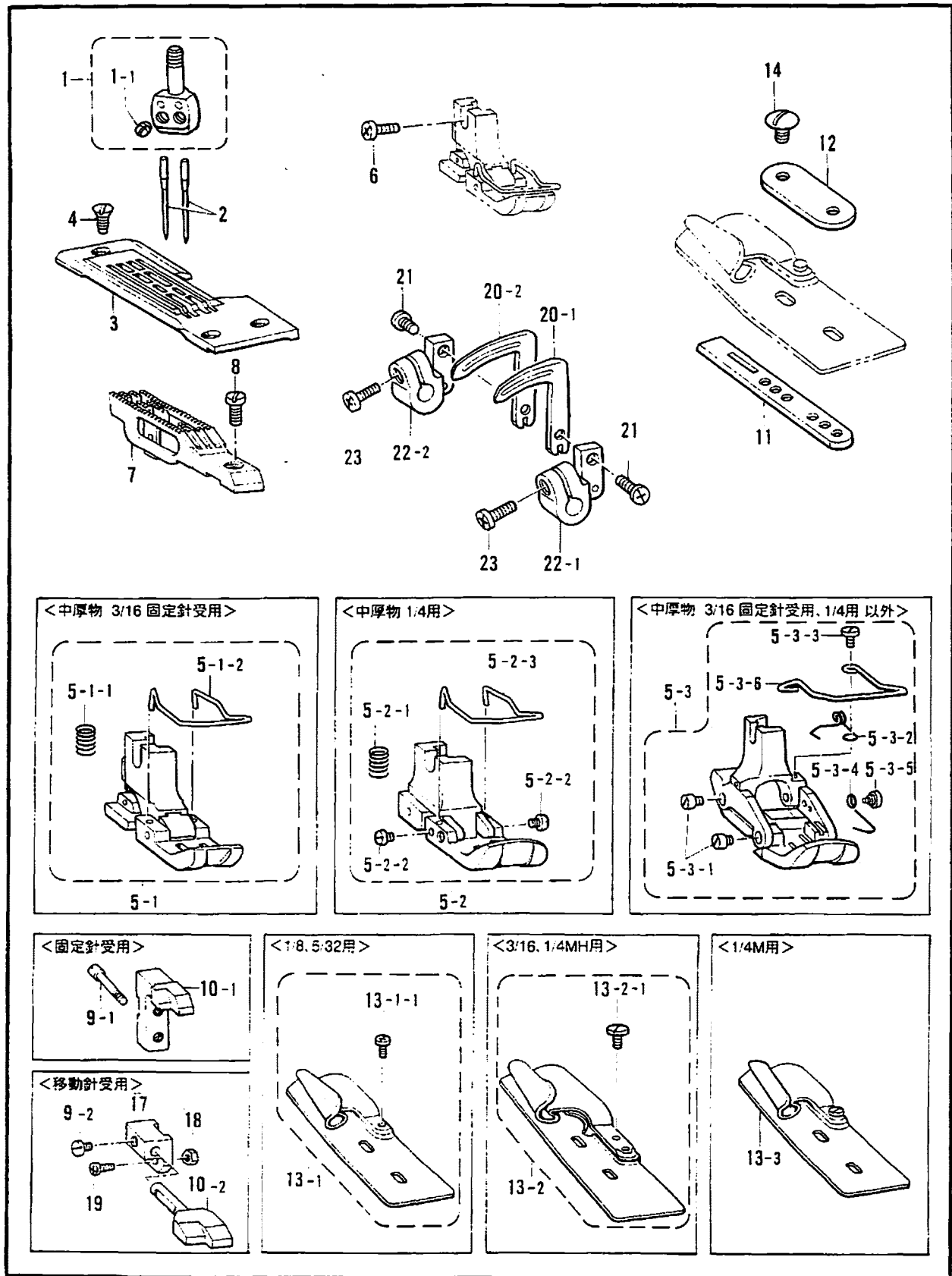

118-927-231

G1. ゲージ関係 (B927スタンダード) / Gauge parts (B927 Standard) / Lehren (B927 Norm)  
 / Pièces du jauge (B927 Standard) / Piezas de calibradores (B927 Norma)

REF.NO.	CODE	Q'TY	ヒンメイ	NAME OF PARTS	RM
1	※	1	ハリダキネジツキ	NEEDLE CALMP ASSY W/S	
1-1	103408002	2	トメネジ4.37	SET SCREW, SM4.37	
2	※	2	ミシンハリ	NEEDLE	
3	※	1	ハリイタ	NEEDLE PLATE	
4	100032004	3	サラネジ4.37	SCREW, FLAT SM4.37	
6	060670812	1	バインド357-40X8	SCREW, BIND SM3.57-40X8	
7	※	1	オクリバ	FEED DOG	
8	105173004	1	シメネジ4.76	SCREW, SM4.76	
11	540399001	1	ラツパーアンナイイタ	LAPPER GUIDE PLATE	
12	105129001	1	アンナイイタザガネ	LAPPER GUIDE PLATE WASHER	
14	105130001	2	シメネジ3.57	SCREW, SM3.57	
20-1	※	1	ルーバS	LOPPER, S	
20-2	※	1	ルーバL	LOPPER, L	
21	062680612	2	ナベコ4.37-40X6	SCREW, PAN SM4.37-40X6	
22-1	506315001	1	ルーハホルダS	LOOPER HOLDER, S	
22-2	506314001	1	ルーハホルダL	LOOPER HOLDER, L	
23	062681012	2	ナベコ437-40X10	SCREW, PAN SM4.37-40X10	
5-1	101491101	1	<中厚物3/16固定針受用> オサエ3/16クミ	< For medium materials 3/16" Fix needle support > PRESSER FOOT ASSY, 3/16"	
5-1-1	105118000	1	オシバネ	SPRING	
5-1-2	156792001	1	フィンガーガード	FINGER GUARD	
5-2	106160101	1	<中厚物1/4用> オサエ1/4Hクミ	< For medium materials 1/4 > PRESSER FOOT ASSY, 1/4" H	
5-2-1	105118000	1	オシバネ	SPRING	
5-2-2	111140001	2	シメネジ2.38	SCREW, SM2.38	
5-2-3	156792001	1	フィンガーガード	FINGER GUARD	
5-3	※	1	<中厚物3/16固定針受, 1/4以外用> オサエクミ	< For without medium materials 3/16, 1/4 > PRESSER FOOT ASSY	
5-3-1	147871001	4	オサエピン	PIN	
5-3-2	540358001	1	オサエMバネ	SPRING	
5-3-3	111105002	1	シメネジ2.38	SCREW, SM2.38	
5-3-4	540360001	1	オサエFバネ	SPRING	
5-3-5	147932001	1	ダンネジ2.38	SHOULDER SCREW, SM2.38	
5-3-6	540374001	1	フィンガーガード	FINGER GUARD	
9-1	105303001	1	<固定針受用> シメネジ3.57	< FOR FIXED NEEDLE GUARD > SCREW, SM3.57	
10-1	※	1	ルーハイトアンナイウデ	LOOPER THREAD GUIDE ARM	
9-2	111443003	1	<移動針受用> マルヒラトメネジ3.57	< FOR MOVEABLE NEEDLE GUARD > SET SCREW, SM3.57	
10-2	※	1	ハリウケ	NEEDLE GUARD	
17	148876001	1	ハリウケトリツケダイ	NEEDLE GUARD BRACKET	
18	021670102	1	ナツト1シユ3.57	NUT, 1 SM3.57	
19	062671012	1	ナベコ357-40X10	SCREW, PAN SM3.57-40X10	
13-1	※	1	<1/8, 5/32用> ラツパークミ	< FOR "1/8, 5/32" > LAPPER ASSY	
13-1-1	062670412	1	ナベコ357-40X4	SCREW, PAN SM3.57-40X4	
13-2	※	1	<3/16, 1/4MH用> ラツパークミ	< FOR "3/16, 1/4MH" > LAPPER ASSY	
13-2-1	105130001	1	シメネジ3.57	SCREW, SM3.57	
13-3	S09679001	1	<1/4M用> ラツパー1/4Mクミ	< FOR "1/4M" > LAPPER ASSY, 1/4" M	

118-927-231

G2. ゲージ関係 (B927 "-7, -8") / Gauge parts (B927 "-7, -8") / Lehren (B927 "-7, -8")  
 / Pièces du jauge (B927 "-7, -8") / Piezas de calibradores (B927 "-7, -8")

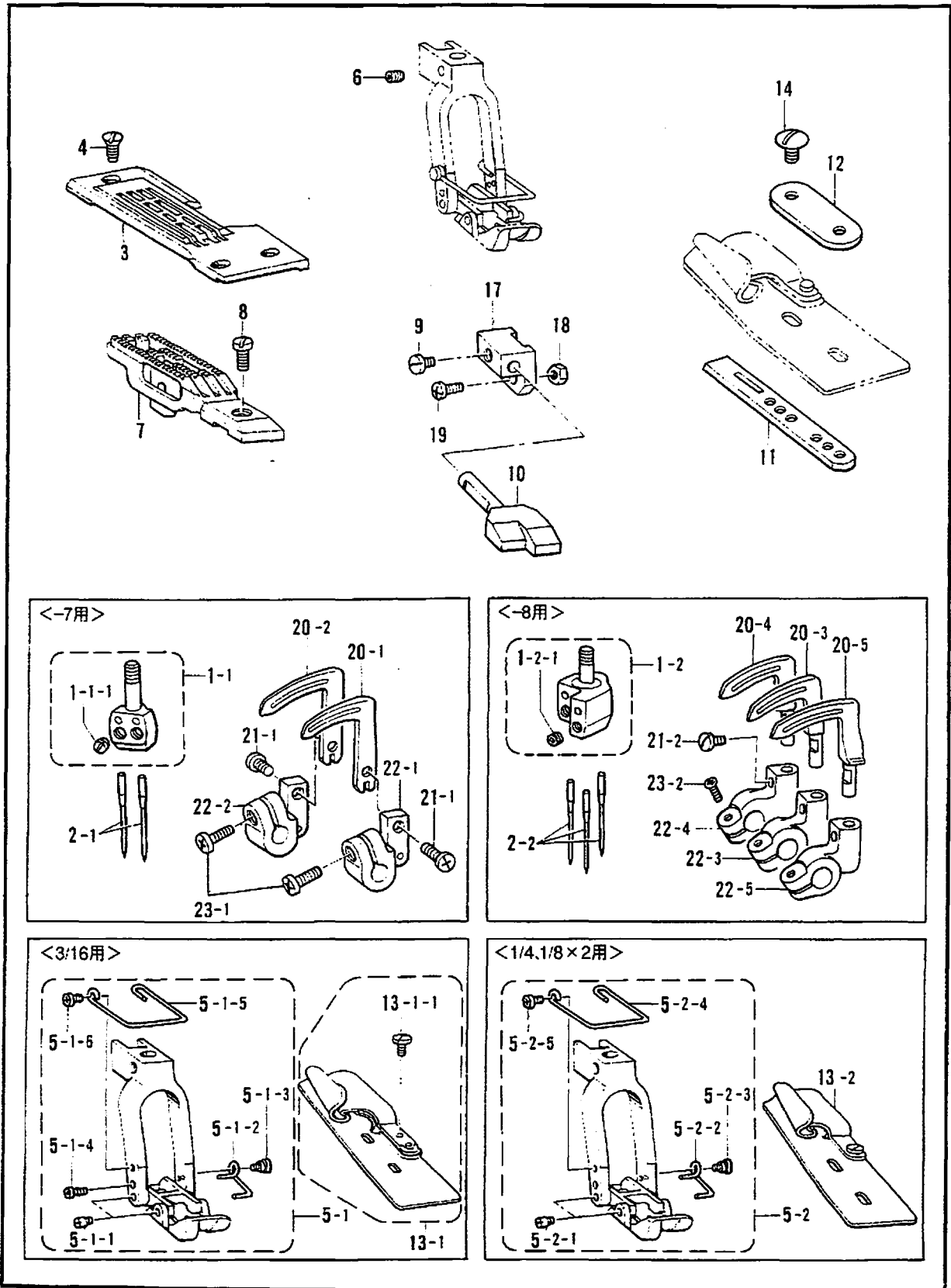

118-927-231

G2. ゲージ関係 (B927 "-7, -8") / Gauge parts (B927 "-7, -8") / Lehren (B927 "-7, -8")  
 / Pièces du jauge (B927 "-7, -8") / Piezas de calibradores (B927 "-7, -8")

REF.NO.	CODE	Q'TY	ヒンメイ	NAME OF PARTS	RM
3	※	1	ハリイタ	NEEDLE PLATE	
4	100032004	3	サラネジ4.37	SCREW, FLAT SM4.37	
6	014760622	1	アナトメネジ5.95	SET SCREW, SOCKET SM5.95	
7	※	1	オクリバ	FEED DOG	
8	105173004	1	シメネジ4.76	SCREW, SM4.76	
9	111443003	1	マルヒラトメネジ3.57	SET SCREW, SM3.57	
10	※	1	ハリウケ	NEEDLE GUARD	
11	S40399001	1	ラツハーアンナイイタ	LAPPER GUIDE PLATE	
12	105129001	1	アンナイイタザガネ	LAPPER GUIDE PLATE WASHER	
14	105130001	2	シメネジ3.57	SCREW, SM3.57	
17	148876001	1	ハリウケトリツケダイ	NEEDLE GUARD BRACKET	
18	021670102	1	ナツト1シユ3.57	NUT, 1 SM3.57	
19	062671012	1	ナベコ357-40X10	SCREW, PAN SM3.57-40X10	
-----					
<-7用>					
1-1	※	1	ハリダキネジツキ	NEEDLE CALMP ASSY W/S	
1-1-1	103408002	2	トメネジ4.37	SET SCREW, SM4.37	
2-1	※	2	ミシンハリTVX64NY	NEEDLE, TVX64NY	
20-1	※	1	ルーパス	LOPPER, S	
20-2	※	1	ルーハL	LOPPER, L	
21-1	062680612	2	ナベコ4.37-40X6	SCREW, PAN SM4.37-40X6	
22-1	S06315001	1	ルーパホルダS	LOOPER HOLDER, S	
22-2	S06314001	1	ルーパホルダL	LOOPER HOLDER, L	
23-1	062681012	2	ナベコ437-40X10	SCREW, PAN SM4.37-40X10	
<-8用>					
1-2	※	1	ハリダキネジツキ	NEEDLE CLAMP ASSY W/S	
1-2-1	146427001	3	アナトメネジ3.18クボミ	SET SCREW, SOCKET (CP) SM3.18	
2-2	※	3	ミシンハリTVX64NY	NEEDLE, TVX64NY	
20-3	S40375001	1	ルーパス1/8X2-6	LOPPER, S 1/8"X2-6	
20-4	S40376001	1	ルーハM-6	LOPPER, M-6	
20-5	S40377001	1	ルーハL1/8X2-6	LOPPER, L 1/8"X2-6	
21-2	111443003	3	マルヒラトメネジ3.57	SET SCREW, SM3.57	
22-3	S40378051	1	ルーパホルダS	LOPPER HOLDER, S	
22-4	S40379051	1	ルーパホルダM	LOPPER HOLDER, M	
22-5	S40380051	1	ルーパホルダL	LOPPER HOLDER, L	
23-2	062671012	3	ナベコ357-40X10	SCREW, PAN SM3.57-40X10	
-----					
<3/16用>					
5-1	S06303101	1	オサエ3/16-7クミ	PRESSER FOOT ASSY, 3/16"-7	
5-1-1	147871001	4	オサエヒン	PIN	
5-1-2	S06309001	1	オサエフバネ	SPRING	
5-1-3	147932001	1	ダンネジ2.38	SHOULDER SCREW, SM2.38	
5-1-4	062630612	1	ナベコ238-56X6	SCREW, PAN SM2.38-56X6	
5-1-5	S09180101	1	フィンガーガード	FINGER GUARD	
5-1-6	060660512	1	バインド318-40X5	SCREW, BIND SM3.18-40X5	
13-1	101494001	1	ラツハー3/16Mクミ	LAPPER ASSY, 3/16" M	
13-1-1	105130001	1	シメネジ3.57	SCREW, SM3.57	
<1/4, 1/8X2用>					
5-2	※	1	オサエクミ	PRESSER FOOT ASSY	
5-2-1	147871001	4	オサエヒン	PIN	
5-2-2	S06309001	1	オサエフバネ	SPRING	
5-2-3	147932001	1	ダンネジ2.38	SHOULDER SCREW, SM2.38	
5-2-4	S09180101	1	フィンガーガード	FINGER GUARD	
5-2-5	060660512	1	バインド318-40X5	SCREW, BIND SM3.18-40X5	
13-2	S09679001	1	ラツハー1/4Mクミ	LAPPER ASSY, 1/4" M	



縫子機用機軸 (B928 スタンダード) / Gauge parts (B928 Standard) / Lehren (B928 Norm)  
 / Pièces du jauge (B928 Standard) / Piezas de calibradores (B928 Norma)

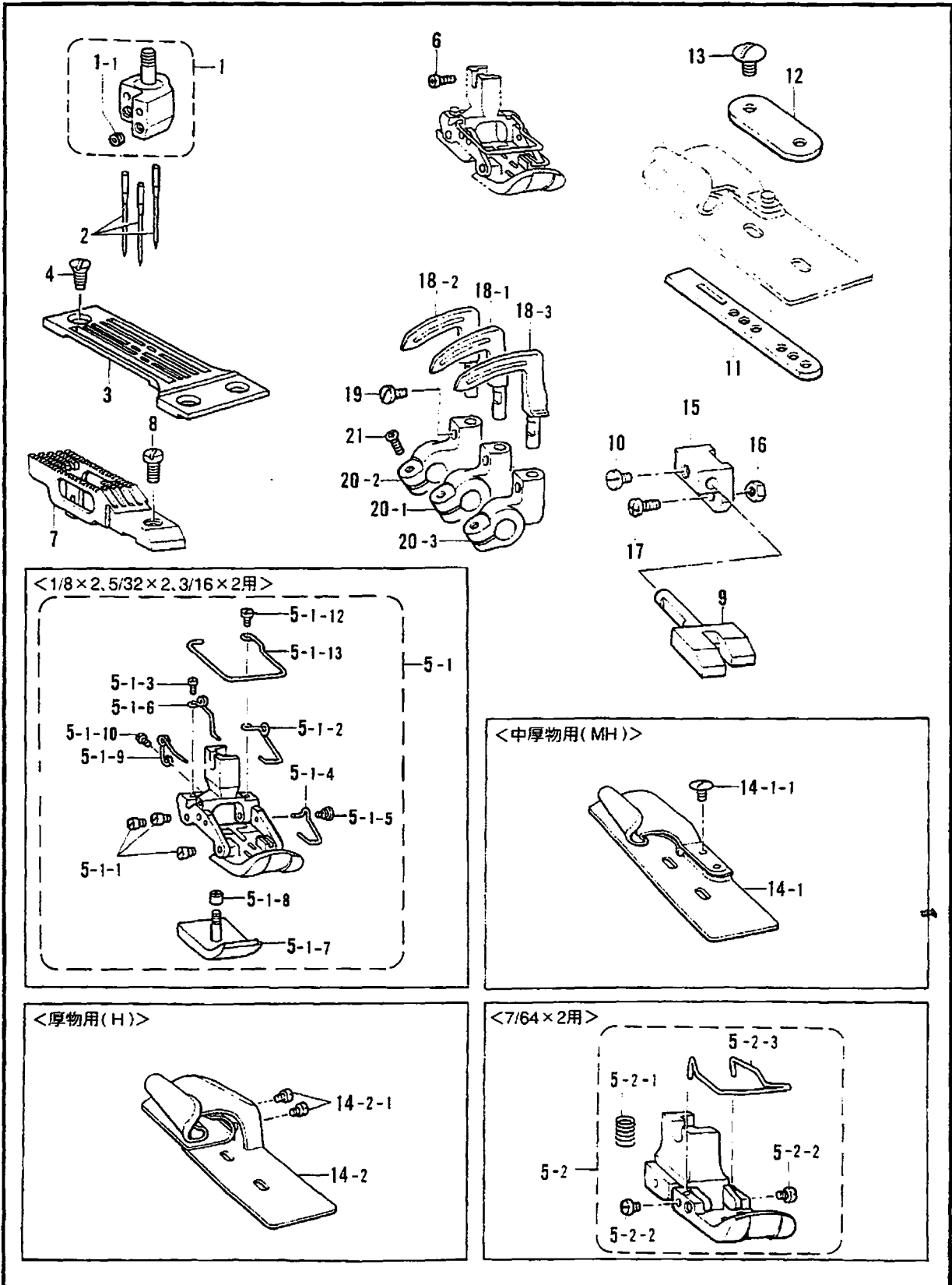

118-928-231

G3. ゲージ関係 (B928 スタンダード) / Gauge parts (B928 Standard) / Lehren (B928 Norm)  
 / Pièces du jauge (B928 Standard) / Piezas de calibradores (B928 Norma)

REF.NO.	CODE	Q'TY	ヒンメイ	NAME OF PARTS	RM
1	※	1	ハリダキクミ	NEEDLE CLAMP ASSY	
1-1	146427001	3	アナトメネジ3.18クボミ	SET SCREW, SOCKET (CP) SM3.18	
2	S43401021	3	ミシンハリTVX5	NEEDLE, TVX5 (#21)	
3	※	1	ハリイタ	NEEDLE PLATE	
4	100032004	3	サラネジ4.37	SCREW, FLAT SM4.37	
6	060670812	1	バインド357-40X8	SCREW, BIND SM3.57-40X8	
7	※	1	オクリバ	FEED DOG	
8	105173004	1	シメネジ4.76	SCREW, SM4.76	
9	148875001	1	ハリウケ-6	NEEDLE GUARD, -6	
10	111443003	1	マルヒラトメネジ3.57	SET SCREW, SM3.57	
11	S40399001	1	ラツパーアンナイイタ	LAPPER GUIDE PLATE	
12	105129001	1	アンナイイタザガネ	LAPPER GUIDE PLATE WASHER	
13	105130001	2	シメネジ3.57	SCREW, SM3.57	
15	148876001	1	ハリウケトリツケダイ	NEEDLE GUARD BRACKET	
16	021670102	1	ナツト1シユ3.57	NUT, 1 SM3.57	
17	062671012	1	ナベコ357-40X10	SCREW, PAN SM3.57-40X10	
18-1	※	1	ルーパス	LOPPER, S	
18-2	※	1	ルーハM	LOPPER, M	
18-3	※	1	ルーパL	LOPPER, L	
19	111443003	3	マルヒラトメネジ3.57	SET SCREW, SM3.57	
20-1	S40378051	1	ルーハホルダS	LOPPER HOLDER, S	
20-2	S40379051	1	ルーハホルダM	LOPPER HOLDER, M	
20-3	S40380051	1	ルーハホルダL	LOPPER HOLDER, L	
21	062671012	3	ナベコ357-40X10	SCREW, PAN SM3.57-40X10	
5-1	※	1	<1/8X2, 5/32X2, 3/16X2用>	<FOR "1/8X2, 5/32X2, 3/16X2">	
5-1-1	147871001	6	オサエクミ	PRESSER FOOT ASSY	
5-1-2	147872001	1	オサエピン	PIN	
5-1-3	S01295001	1	オサエM/バネ	SPRING	
5-1-4	147890001	1	シメネジ2.38X3.5	SCREW, SM2.38X3.5	
5-1-5	147932001	1	オサエF/バネ	SPRING	
5-1-6	147875001	1	ダンネジ2.38	SHOULDER SCREW, SM2.38	
5-1-8	147877001	1	オサエBL/バネ	SPRING	
5-1-8	147877001	1	ツマミナツト3.18	NUT, SM3.18	
5-1-9	147878001	1	オサエBS/バネ	SPRING	
5-1-10	062660512	1	ナベコネジ318-40X5	SCREW, PAN SM3.18-40X5	
5-1-12	111105002	1	シメネジ2.38	SCREW, SM2.38	
5-1-13	151572101	1	フィンガーガード	FINGER GUARD	
5-1-7	S40804001	1	<5/32X2, 3/16X2用>	<FOR "5/32X2, 3/16X2">	
			オサエBS5/16	PRESSER FOOT, BS 5/16"	
5-1-7	147876001	1	<1/8X2用>	<FOR "1/8X2">	
			オサエBS	PRESSER FOOT, BS	
5-2	S40788001	1	<7/64X2用>	<FOR "7/64X2">	
			オサエ7/64X2クミ	PRESSER FOOT ASSY, 7/64"X2	
5-2-1	S09397001	1	オサエオシバネ	SPRING	
5-2-2	153787001	2	シメネジ2.38	SCREW, SM2.38	
5-2-3	151571001	1	フィンガーガード	FINGER GUARD	
14-1	※	1	<中厚物用 (MH)>	<FOR MEDIUM MATERIALS "MH">	
14-1-1	105130001	1	ラツパーMHクミ	LAPPER ASSY, MH	
			シメネジ3.57	SCREW, SM3.57	
14-2	※	1	<厚物用 (H)>	<FOR THICK MATERIALS "H">	
14-2-1	122771001	2	ラツパーHクミ	LAPPER ASSY, H	
			シメネジ2.38	SCREW, SM2.38	

118-928-231

G4. ゲージ関係 (B928 "-5") / Gauge parts (B928 "-5") / Lehren (B928 "-5")  
 / Pièces du jauge (B928 "-5") / Piezas de calibradores (B928 "-5")

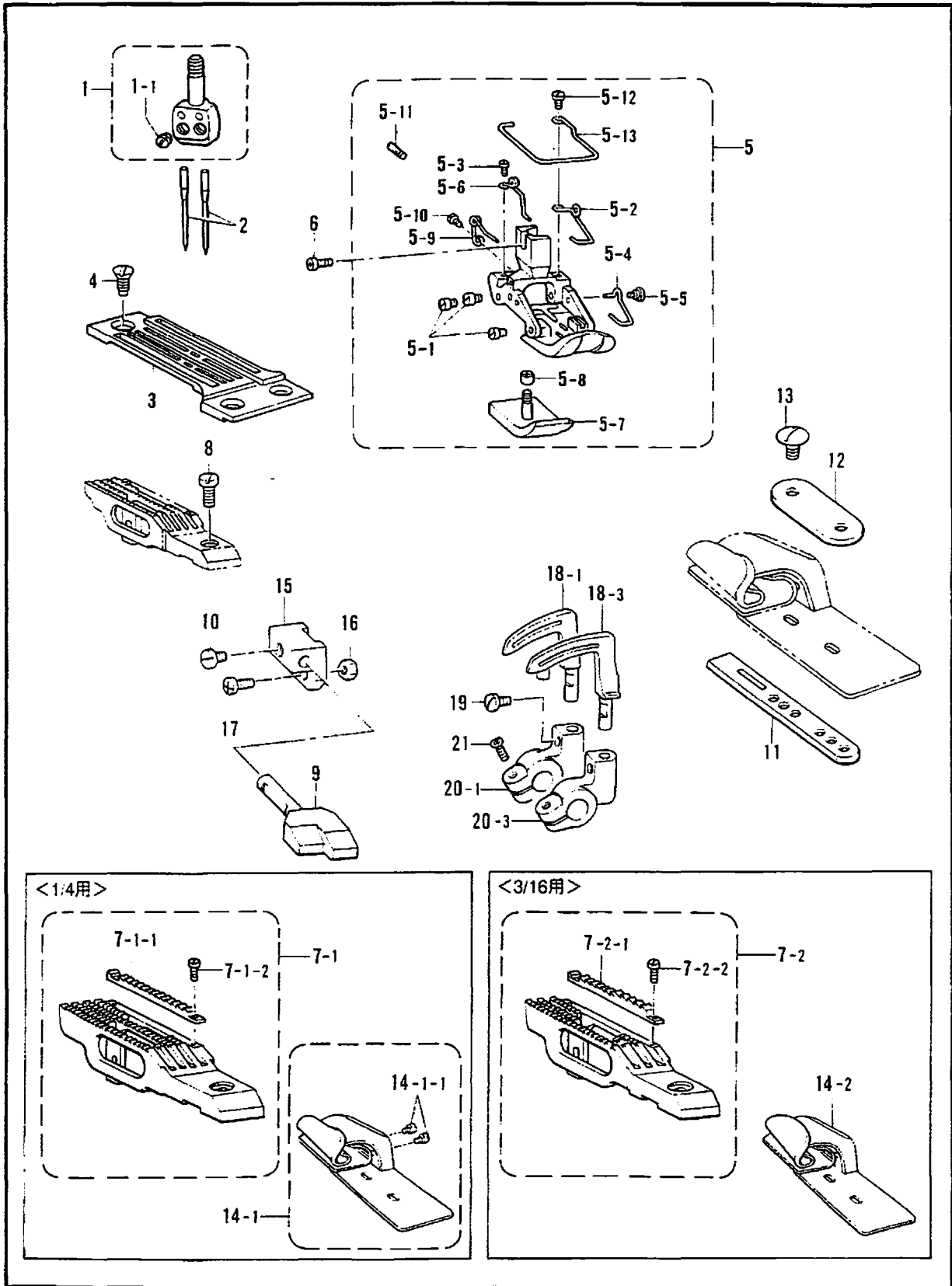

118-928-231

G4. ゲージ関係 (B928 "-5") / Gauge parts (B928 "-5") / Lehren (B928 "-5")  
 / Pièces du jauge (B928 "-5") / Piezas de calibradores (B928 "-5")

REF.NO.	CODE	Q'TY	ヒンメイ	NAME OF PARTS	RM
1	※	1	ハリダキネジツキ	NEEDLE CLAMP ASSY W/S	
1-1	103408002	2	トメネジ4.37	SET SCREW, SM4.37	
2	※	3	ミシンハリTVX5	NEEDLE, TVX5	
3	※	1	ハリイタ	NEEDLE PLATE	
4	100032004	3	サラネジ4.37	SCREW, FLAT SM4.37	
5	※	1	オサエクミ	PRESSER FOOT ASSY	
5-1	147871001	6	オサエヒン	PIN	
5-2	147872001	1	オサエMバネ	SPRING	
5-3	501295001	1	シメネジ2.38X3.5	SCREW, SM2.38X3.5	
5-4	147890001	1	オサエFバネ	SPRING	
5-5	147932001	1	ダンネジ2.38	SHOULDER SCREW, SM2.38	
5-6	147875001	1	オサエBLバネ	SPRING	
5-8	147877001	1	ツマミナツト3.18	NUT, SM3.18	
5-9	147878001	1	オサエBSバネ	SPRING	
5-10	062660512	1	ナベコネジ318-40X5	SCREW, PAN SM3.18-40X5	
5-11	147879001	1	トメネジ3.18	SET SCREW, SM3.18	
5-12	111105002	1	シメネジ2.38	SCREW, SM2.38	
5-13	151572101	1	フィンガーガード	FINGER GUARD	
6	060670812	1	バインド357-40X8	SCREW, BIND SM3.57-40X8	
8	105173004	1	シメネジ4.76	SCREW, SM4.76	
9	148973001	1	ハリウケ-5	NEEDLE GUARD, -5	
10	111443003	1	マルヒラトメネジ3.57	SET SCREW, SM3.57	
11	S40399001	1	ラツパーアンナイイタ	LAPPER GUIDE PLATE	
12	105129001	1	アンナイイタザガネ	LAPPER GUIDE PLATE WASHER	
13	105130001	2	シメネジ3.57	SCREW, SM3.57	
15	148876001	1	ハリウケトリツケダイ	NEEDLE GUARD BRACKET	
16	021670102	1	ナツト1シユ3.57	NUT, 1 SM3.57	
17	062671012	1	ナベコ357-40X10	SCREW, PAN SM3.57-40X10	
18-1	S40375001	1	ルーバS1/8X2-6	LOPPER, S 1/8" X2-6	
18-3	S40377001	1	ルーバL1/8X2-6	LOPPER, L 1/8" X2-6	
19	111443003	3	マルヒラトメネジ3.57	SET SCREW, SM3.57	
20-1	S40378051	1	ルーバホルダS	LOPPER HOLDER, S	
20-3	S40380051	1	ルーバホルダL	LOPPER HOLDER, L	
21	062671012	2	ナベコ357-40X10	SCREW, PAN SM3.57-40X10	
-----					
5-7	147876001	1	<1/4用> オサエBS	<FOR"1/4"> PRESSER FOOT, BS	
7-1	148971001	1	オクリバ1/4クミ	FEED DOG ASSY, 1/4"	
7-1-1	147307001	1	トリツケバ	SUB FEED DOG	
7-1-2	147880001	2	シメネジ1.98	SCREW, SM1.98	
14-1	147302001	1	ラツパー1/4XHクミ	LAPPER ASSY, 1/4" XH	
14-1-1	122771001	2	シメネジ2.38	SCREW, SM2.38	
5-7	159587001	1	<3/16用> オサエBS3/18	<FOR"3/16"> PRESSER FOOT, BS 3/18"	
7-2	159588001	1	オクリバ3/16クミ	FEED DOG ASSY, 3/16"	
7-2-1	159590001	1	トリツケバ	SUB FEED DOG	
7-2-2	147880001	2	シメネジ1.98	SCREW, SM1.98	
14-2	159609001	1	ラツパー3/16Hクミ	LAPPER ASSY, 3/16" H	

118-928-231

G5 . ゲージ関係 (B928 "6") / Gauge parts (B928 "6") / Lehren (B928 "6")  
 / Pièces du jauge (B928 "6") / Piezas de calibradores (B928 "6")

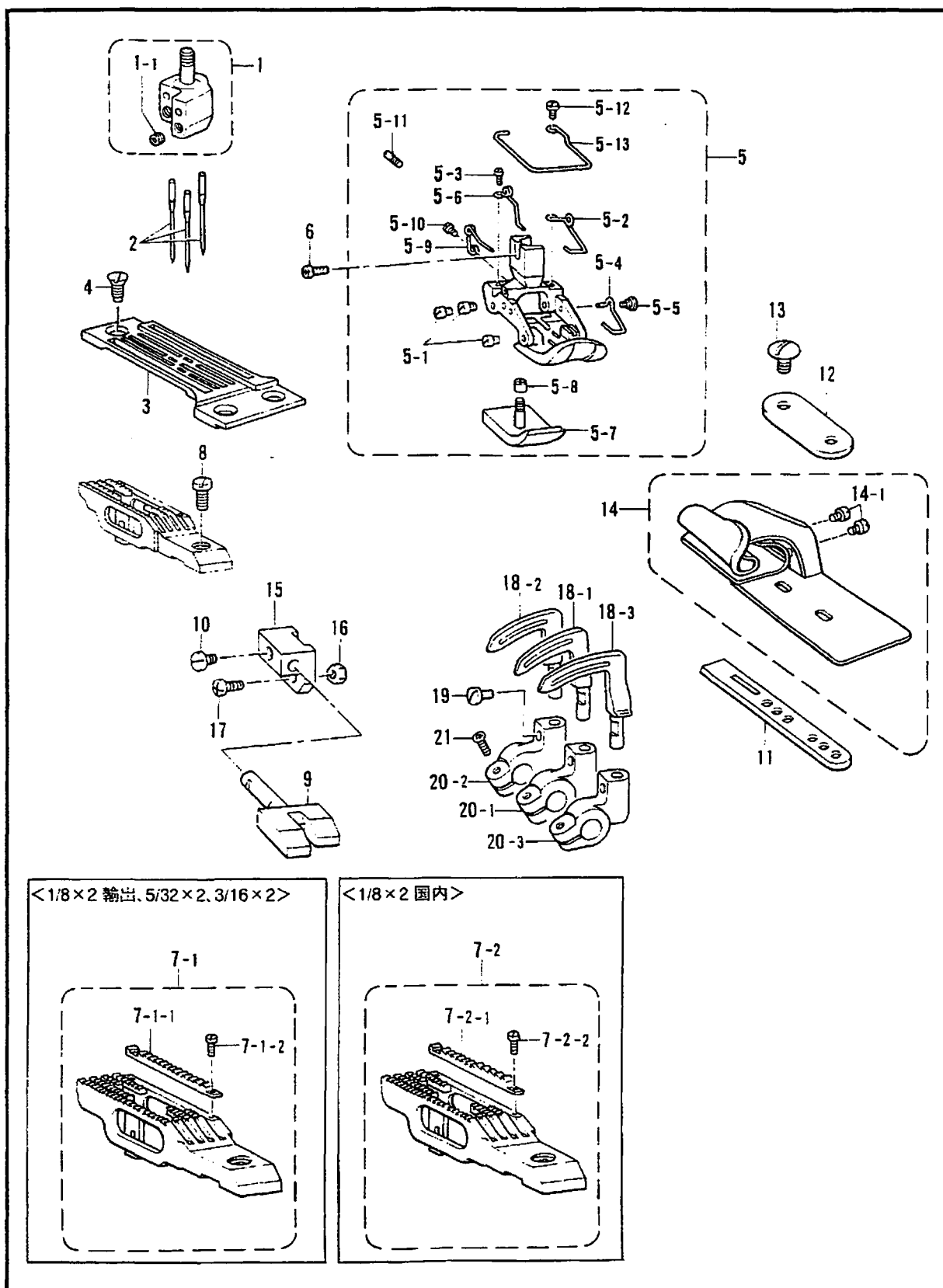

118-928-231

G5. ゲージ関係 (B928 "-6") / Gauge parts (B928 "-6") / Lehren (B928 "-6")  
 / Pièces du jauge (B928 "-6") / Piezas de calibradores (B928 "-6")

REF.NO.	CODE	Q'TY	ヒンメイ	NAME OF PARTS	RM
1	※	1	ハリダキクミ	NEEDLE CLAMP ASSY	
1-1	146427001	3	アナトメネジ3.18クボミ	SET SCREW, SOCKET (CP) SM3.18	
2	111128022	3	ミシンハリTVX5	NEEDLE, TVX5 (#22)	
3	※	1	ハリイタ	NEEDLE PLATE	
4	100032004	3	サラネジ4.37	SCREW, FLAT SM4.37	
5	※	1	オサエクミ	PRESSER FOOT ASSY	
5-1	147871001	6	オサエピン	PIN	
5-2	147872001	1	オサエMバネ	SPRING	
5-3	501295001	1	シメネジ2.38X3.5	SCREW, SM2.38X3.5	
5-4	147890001	1	オサエFバネ	SPRING	
5-5	147932001	1	ダンネジ2.38	SHOULDER SCREW, SM2.38	
5-6	147875001	1	オサエ8Lバネ	SPRING	
5-7	147876001	1	オサエBS	PRESSER FOOT, BS	
5-8	147877001	1	ツマミナツト3.18	NUT, SM3.18	
5-9	147878001	1	オサエBSバネ	SPRING	
5-10	062660512	1	ナベコネジ318-40X5	SCREW, PAN SM3.18-40X5	
5-11	147879001	1	トメネジ3.18	SET SCREW, SM3.18	
5-12	111105002	1	シメネジ2.38	SCREW, SM2.38	
5-13	151572101	1	フィンガーガード	FINGER GUARD	
6	060670812	1	バインド357-40X8	SCREW, BIND SM3.57-40X8	
8	105173004	1	シメネジ4.76	SCREW, SM4.76	
9	148875001	1	ハリウケ-6	NEEDLE GUARD, -6	
10	111443003	1	マルヒラトメネジ3.57	SET SCREW, SM3.57	
11	540399001	1	ラツパーアンナイイタ	LAPPER GUIDE PLATE	
12	105129001	1	アンナイイタザガネ	LAPPER GUIDE PLATE WASHER	
13	105130001	2	シメネジ3.57	SCREW, SM3.57	
14	※	1	ラツパークミ	LAPPER ASSY	
14-1	122771001	2	シメネジ2.38	SCREW, SM2.38	
15	148876001	1	ハリウケトリツケダイ	NEEDLE GUARD BRACKET	
16	021670102	1	ナツト1シユ3.57	NUT, 1 SM3.57	
17	062671012	1	ナベコ357-40X10	SCREW, PAN SM3.57-40X10	
18-1	540375001	1	ルーバS1/8X2-6	LOPPER, S 1/8"X2-6	
18-2	540376001	1	ルーハM-6	LOPPER, M-6	
18-3	540377001	1	ルーハL1/8X2-6	LOPPER, L 1/8"X2-6	
19	111443003	3	マルヒラトメネジ3.57	SET SCREW, SM3.57	
20-1	540378051	1	ルーハホルダS	LOPPER HOLDER, S	
20-2	540379051	1	ルーハホルダM	LOPPER HOLDER, M	
20-3	540380051	1	ルーハホルダL	LOPPER HOLDER, L	
21	062671012	3	ナベコ357-40X10	SCREW, PAN SM3.57-40X10	
<hr/>					
7-1	※	1	<1/8X2輸出用, 5/32X2,3/16X2用>	<FOR EXPORT "1/5X2" & 5/32X2,3/16X2>	
7-1-1	147307001	1	オクリバクミ	FEED DOG ASSY	
7-1-2	147880001	2	トリツケバ	SUB FEED DOG	
		2	シメネジ1.98	SCREW, SM1.98	
7-2	S18084101	1	<1/8X2国内用>	<FOR JAPAN ONLY>	
7-2-1	S01637001	1	オクリバ1/8X2クミD1	-----	
7-2-2	147880001	2	トリツケバ	-----	
		2	シメネジ1.98	-----	

G6. ゲージ関係 (B928 "-7") / Gauge parts (B928 "-7") / Lehren (B928 "-7")  
 / Pièces du jauge (B928 "-7") / Piezas de calibradores (B928 "-7")

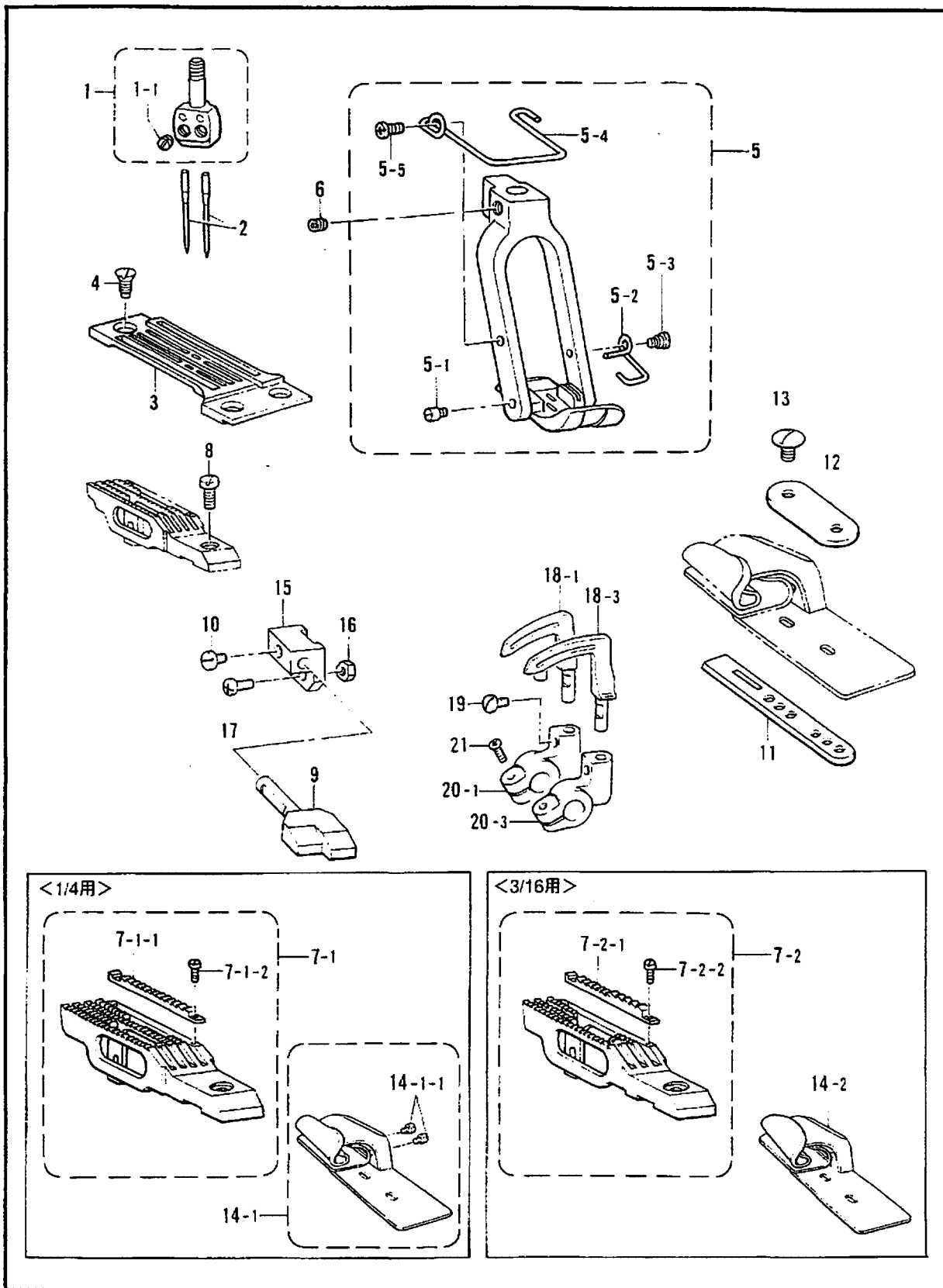

118-928-231

G6. ゲージ関係 (B928 "-7") / Gauge parts (B928 "-7") / Lehren (B928 "-7")  
 / Pièces du jauge (B928 "-7") / Piezas de calibradores (B928 "-7")

REF.NO.	CODE	Q'TY	ヒンメイ	NAME OF PARTS	RM
1	※	1	ハリダキネジツキ	NEEDLE CLAMP ASSY W/S	
1-1	103408002	2	トメネジ4.37	SET SCREW, SM4.37	
2	※	2	ミシンハリTVX5	NEEDLE, TVX5	
3	※	1	ハリイタ	NEEDLE PLATE	
4	100032004	3	サラネジ4.37	SCREW, FLAT SM4.37	
5	※	1	オサエクミ	PRESSER FOOT ASSY	
5-1	150670001	2	オサエピン	PIN	
5-2	150671001	1	オサエフバネ	SPRING	
5-3	147932001	1	ダンネジ2.38	SHOULDER SCREW, SM2.38	
5-4	156211101	1	フィンガーガード	FINGER GUARD	
5-5	060660512	1	バインド318-40X5	SCREW, BIND SM3.18-40X5	
6	014760622	1	アナトメネジ5.95	SET SCREW, SOCKET SM5.95	
8	105173004	1	シメネジ4.76	SCREW, SM4.76	
9	148973001	1	ハリウケ-5	NEEDLE GUARD, -5	
10	111443003	1	マルヒラトメネジ3.57	SET SCREW, SM3.57	
11	S40399001	1	ラツパーアンナイイタ	LAPPER GUIDE PLATE	
12	105129001	1	アンナイイタザガネ	LAPPER GUIDE PLATE WASHER	
13	105130001	2	シメネジ3.57	SCREW, SM3.57	
15	148876001	1	ハリウケトリツケダイ	NEEDLE GUARD BRACKET	
16	021670102	1	ナツト1シユ3.57	NUT, 1 SM3.57	
17	062671012	1	ナベコ357-40X10	SCREW, PAN SM3.57-40X10	
18-1	S40375001	1	ルーハS1/8X2-6	LOPPER, S 1/8"X2-6	
18-3	S40377001	1	ルーハL1/8X2-6	LOPPER, L 1/8"X2-6	
19	111443003	2	マルヒラトメネジ3.57	SET SCREW, SM3.57	
20-1	S40378051	1	ルーハホルダS	LOPPER HOLDER, S	
20-3	S40380051	1	ルーハホルダL	LOPPER HOLDER, L	
21	062671012	2	ナベコ357-40X10	SCREW, PAN SM3.57-40X10	
-----					
			<1/4用>	<FOR "1/4">	
7-1	150673001	1	オクリバ1/4-7クミ	FEED DOG ASSY, 1/4"-7	
7-1-1	147307001	1	トリツケバ	SUB FEED DOG	
7-1-2	147880001	2	シメネジ1.98	SCREW, SM1.98	
14-1	147302001	1	ラツパー1/4XHクミ	LAPPER ASSY, 1/4" XH	
14-1-1	122771001	2	シメネジ2.38	SCREW, SM2.38	
			<3/16用>	<FOR "3/16">	
7-2	159616001	1	オクリバ3/16-7クミ	FEED DOG ASSY, 3/16"-7	
7-2-1	159590001	1	トリツケバ	SUB FEED DOG	
7-2-2	147880001	2	シメネジ1.98	SCREW, SM1.98	
14-2	159609001	1	ラツパー3/16Hクミ	LAPPER ASSY, 3/16" H	

118-928-231



G7. ゲージ関係 (B928 "-8") / Gauge parts (B928 "-8") / Lehren (B928 "-8")  
 / Pièces du jauge (B928 "-8") / Piezas de calibradores (B928 "-8")

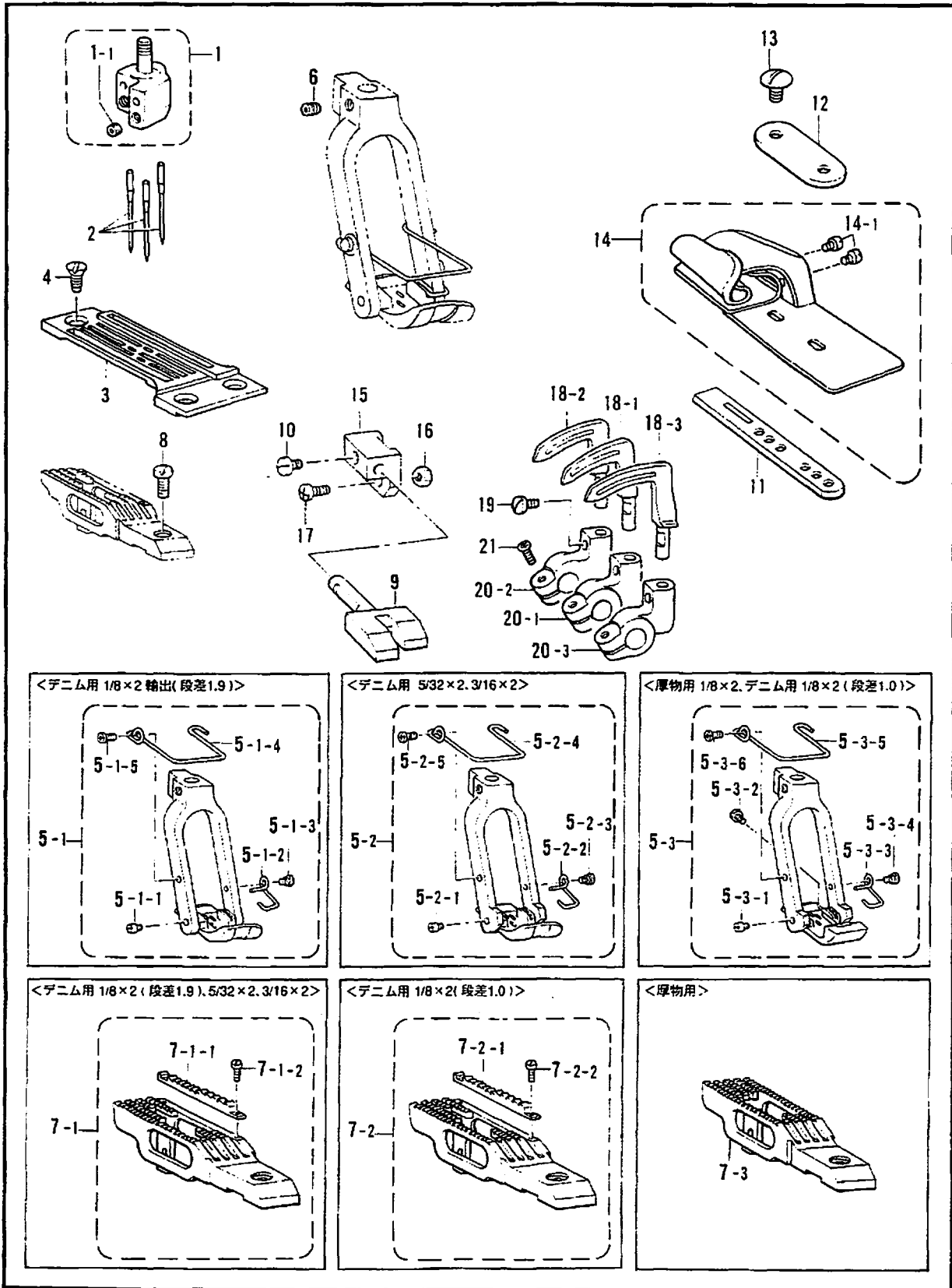

118-928-231

G7 . ゲージ関係 (B928 "-8") / Gauge parts (B928 "-8") / Lehren (B928 "-8")  
 / Pièces du jauge (B928 "-8") / Piezas de calibradores (B928 "-8")

REF.NO.	CODE	Q'TY	ヒンメイ	NAME OF PARTS	RM
1	※	1	ハリダキクミ	NEEDLE CLAMP ASSY	
1-1	146427001	3	アナトメネジ3.18クボミ	SET SCREW, SOCKET (CP) SM3.18	
2	※	3	ミシンハリTVX5	NEEDLE, TVX5	
3	※	1	ハリイタ	NEEDLE PLATE	
4	100032004	3	サラネジ4.37	SCREW, FLAT SM4.37	
6	014760622	1	アナトメネジ5.95	SET SCREW, SOCKET SM5.95	
8	105173004	1	シメネジ4.76	SCREW, SM4.76	
9	148875001	1	ハリウケ-6	NEEDLE GUARD, -6	
10	111443003	1	マルヒラトメネジ3.57	SET SCREW, SM3.57	
11	S40399001	1	ラツパーアンナイイタ	LAPPER GUIDE PLATE	
12	105129001	1	アンナイイタザガネ	LAPPER GUIDE PLATE WASHER	
13	105130001	2	シメネジ3.57	SCREW, SM3.57	
14	※	1	ラツパークミ	LAPPER ASSY	
14-1	122771001	2	シメネジ2.38	SCREW, SM2.38	
15	148876001	1	ハリウケトリツケダイ	NEEDLE GUARD BRACKET	
16	021670102	1	ナツト1シユ3.57	NUT, 1 SM3.57	
17	062671012	1	ナベコ357-40X10	SCREW, PAN SM3.57-40X10	
18-1	※	1	ルーパス	LOPPER, S 1/8"X2-6	
18-2	※	1	ルーハM	LOPPER, M 1/8"X2-6	
18-3	※	1	ルーハL	LOPPER, L 1/8"X2-6	
19	111443003	3	マルヒラトメネジ3.57	SET SCREW, SM3.57	
20-1	S40378051	1	ルーパホルダS	LOPPER HOLDER, S	
20-2	S40379051	1	ルーパホルダM	LOPPER HOLDER, M	
20-3	S40380051	1	ルーパホルダL	LOPPER HOLDER, L	
21	062671012	3	ナベコ357-40X10	SCREW, PAN SM3.57-40X10	
-----					
<デニム用1/8X2輸出段差1.9>				<For Export Denim "1/8X2">	
5-1	150672101	1	オサエ1/8X2-8クミ	PRESSER FOOT ASSY, 1/8"X2-8	
5-1-1	150670001	2	オサエピン	PIN	
5-1-2	150671001	1	オサエFバネ	SPRING	
5-1-3	147932001	1	ダンネジ2.38	SHOULDER SCREW, SM2.38	
5-1-4	156211101	1	フィンガーガード	FINGER GUARD	
5-1-5	060660512	1	バインド318-40X5	SCREW, BIND SM3.18-40X5	
<デニム用5/32X2, 3/16X2>				<For Denim 5/32X2, 3/16X2>	
5-2	151487101	1	オサエ5/32X2-8クミ	PRESSER FOOT ASSY, 5/32"X2-8	
5-2-1	151481001	2	オサエピン	PIN	
5-2-2	151482001	1	オサエFバネ	SPRING	
5-2-3	147932001	1	ダンネジ2.38	SHOULDER SCREW, SM2.38	
5-2-4	156211101	1	フィンガーガード	FINGER GUARD	
5-2-5	060660512	1	バインド318-40X5	SCREW, BIND SM3.18-40X5	
<厚物用1/8x2, デニム1/8x2段差1.0>				<For Thick & Denim materials "1/8X2">	
5-3	※	1	オサエ1/8X2-8クミ	PRESSER FOOT ASSY, FT 1/8"X2-8	
5-3-1	150670001	2	オサエピン	PIN	
5-3-2	142747002	1	シメネジ4.76	SET SCREW, SM4.76	
5-3-3	150671001	1	オサエFバネ	SPRING	
5-3-4	147932001	1	ダンネジ2.38	SHOULDER SCREW, SM2.38	
5-3-5	156211101	1	フィンガーガード	FINGER GUARD	
5-3-6	060660512	1	バインド318-40X5	SCREW, BIND SM3.18-40X5	
-----					
<デニム1/8x2段差1.9, 5/32x2, 3/16x2>				<For Denim "1/8X2, 5/32X2 & 3/16X2">	
7-1	※	1	オクリバクミ	FEED DOG ASSY, 1/4"-7	
7-1-1	147307001	1	トリツケバ	SUB FEED DOG	
7-1-2	147880001	2	シメネジ1.98	SCREW, SM1.98	
<デニム用1/8x2段差1.0>				<For Denim "1.8X2">	
7-2	S01635101	1	オクリバ1/8X2-8クミ	FEED DOG ASSY, 1/8"X2-8	
7-2-1	S01637001	1	トリツケバ	SUB FEED DOG	
7-2-2	147880001	2	シメネジ1.98	SCREW, SM1.98	
<厚物用>				<FOR HEAVY MATERIALS>	
7-3	156182101	1	オクリバ1/8X2-8	FEED DOG, 1/8"X2-8	

H. プーラ装置関係 (-7, -8) / Puller device mechanism (-7, -8) / Ziehvorrichtung (-7, -8)  
 / Mécanisme due puller (-7, -8) / Mecanismo del dispositivo de arrastre (-7, -8)

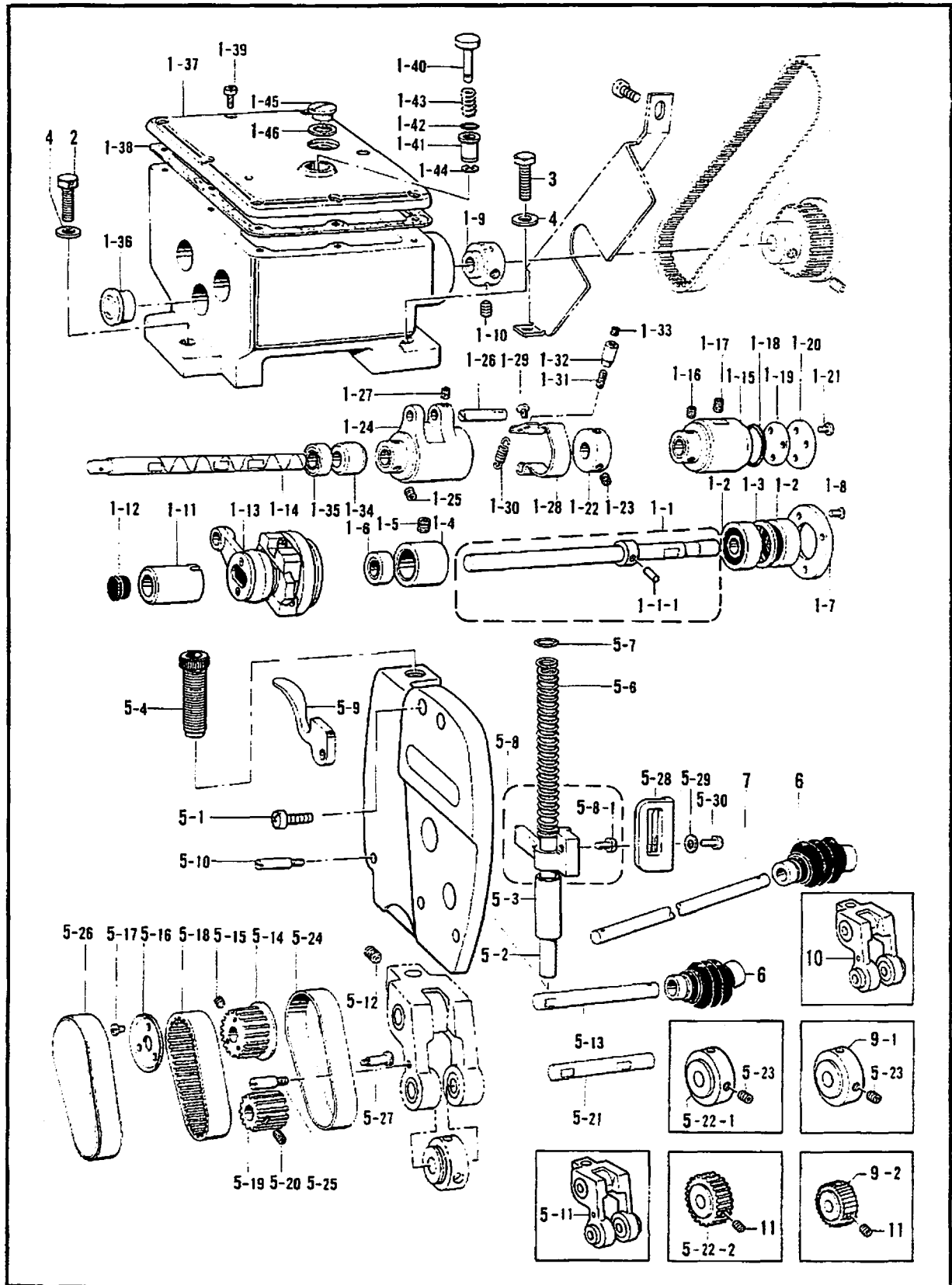

119-927-241

H. プーラ装置関係 (-7, -8) / Puller device mechanism (-7, -8) / Ziehvorrichtung (-7, -8)  
 / Mécanisme due puller (-7, -8) / Mecanismo del dispositivo de arrastre (-7, -8)

REF.NO.	CODE	Q'TY	ヒンメイ	NAME OF PARTS	R/M
1-1	150679001	1	ヘンシンリンジククミ	ECCENTRIC WHEEL SHAFT ASSY	
1-1-1	047201640	1	スプリングヒンAW2	PIN, SPRING ROLL AW2	
1-2	072600040	2	タマジクウケ6000DD	BALL BEARING, 6000DD	
1-3	150682000	1	ベアリングカラー	BEARING COLLAR	
1-4	150683000	1	ベアリングブシユ	BEARING BUSH	
1-5	014760622	1	アナトメネジ5.95	SET SCREW, SOCKET SMS.95	
1-6	150684001	1	オイルシール	OIL SEAL	
1-7	525125001	1	ベアリングフタ	BEARING COVER	
1-8	062670712	3	ナベコ357-40X7	SCREW, PAN SM3.57-40X7	
1-9	150686101	1	タイミングカラー	TIMING COLLAR	
1-10	014760622	2	アナトメネジ5.95	SET SCREW, SOCKET SMS.95	
1-11	150687000	1	ヘンシンリンジクメタル	ECCENTRIC WHEEL SHAFT BUSH	
1-12	117934009	1	ゴムセン13.5	RUBBER CAP, 13.5	
1-13	150688101	1	ヘンシンリンクミ	ECCENTRIC WHEEL ASSY	
1-14	150690101	1	オクリジク	FEED SHAFT	
1-15	536058001	1	クラッチメタルクミ	CLUTCH BUSH ASSY	
1-16	014760622	2	アナトメネジ5.95	SET SCREW, SOCKET SMS.95	
1-17	014760622	1	アナトメネジ5.95	SET SCREW, SOCKET SMS.95	
1-18	081025570	1	OリングP25.5	O RING, P25.5	
1-19	150693000	1	パツキン	PACKING	
1-20	525126001	1	クラッチメタルフタ	CLUTCH BUSH CAP	
1-21	062670712	3	ナベコ357-40X7	SCREW, PAN SM3.57-40X7	
1-22	150608001	1	セツトカラー	SET SCREW COLLAR	
1-23	014760622	2	アナトメネジ5.95	SET SCREW, SOCKET SMS.95	
1-24	536061001	1	クラッチクミ	CLUTCH ASSY	
1-25	014760622	2	アナトメネジ5.95	SET SCREW, SOCKET SMS.95	
1-26	109153001	1	ピン	PIN	
1-27	014680422	1	アナトメネジ4.37クボミ	SET SCREW, SOCKET (CP) SM4.37	
1-28	150611001	1	ブレーキイタバネ	PLATE SPRING	
1-29	062680512	2	ナベコ437-40X5	SCREW, PAN SM4.37-40X5	
1-30	150612001	1	ブレーキバネ	SPRING	
1-31	150613001	1	ブレーキバネカケ	SPRING HOOK	
1-32	150614001	1	ブレーキバネカケブシユ	SPRING HOOK BUSH	
1-33	148294001	1	アナトメネジ3.57クボミ	SET SCREW, SOCKET (CP) SM3.57	
1-34	150695000	1	オクリジクメタル	FEED SHAFT BUSH	
1-35	150696001	1	オイルシール	OIL SEAL	
1-36	150697001	1	オイルホツトマド	OIL GAUGE WINDOW	
1-37	150698009	1	プーラソウチウワフタ	PULLER DEVICE TOP COVER	
1-38	150699000	1	パツキン	PACKING	
1-39	062671012	8	ナベコ357-40X10	SCREW, PAN SM3.57-40X10	
1-40	150641001	1	オクリチヨウセツボタン	FEED ADJUST BUTTON	
1-41	150700001	1	チヨウセツボタンブシユ	FEED REGURATE BUTTON BUSH	
1-42	081003670	1	OリングPW3	O RING, PW3	
1-43	150701001	1	オクリチヨウセツボタンバネ	SPRING	
1-44	048040342	1	トメワE4	RETAINING RING, E4	
1-45	105113001	1	シメネジ12.70	SCREW, SM12.70	
1-46	105215001	1	パツキン	PACKING	
2	017822212	1	ボルト7.94X22	BOLT, SM7.94X22	
3	017821813	2	ボルト7.94X18	BOLT, SM7.94X18	
4	025080132	3	ヒラザガネシヨウ8	WASHER, PLAIN S 8	
5-1	062681012	4	ナベコ437-40X10	SCREW, PAN SM4.37-40X10	
5-2	150704001	1	プーラオサエボウ	PULLER PRESSER BAR	
5-3	541314000	1	オサエボウメタルD	PRESSER BAR BUSH, D	
5-4	100279109	1	オサエチヨウセツネジ	PRESSER ADJUST SCREW	
5-5	106794001	1	オサエバネ	SPRING	
5-7	141099001	1	オサエバネザガネ	SPRING WASHER	
5-8	183128001	1	オサエボウアンナイクミ	PRESSER BAR GUIDE ASSY	
5-8-1	062680712	1	ナベコ437-40X7	SCREW, PAN SM4.37-40X7	
5-9	112618001	1	オサエアゲ	PRESSER FOOT LIFTER	

118-927-241

H. プーラ装置関係 (-7, -8) / Puller device mechanism (-7, -8) / Ziehvorrichtung (-7, -8)  
 / Mécanisme due puller (-7, -8) / Mecanismo del dispositivo de arrastre (-7, -8)

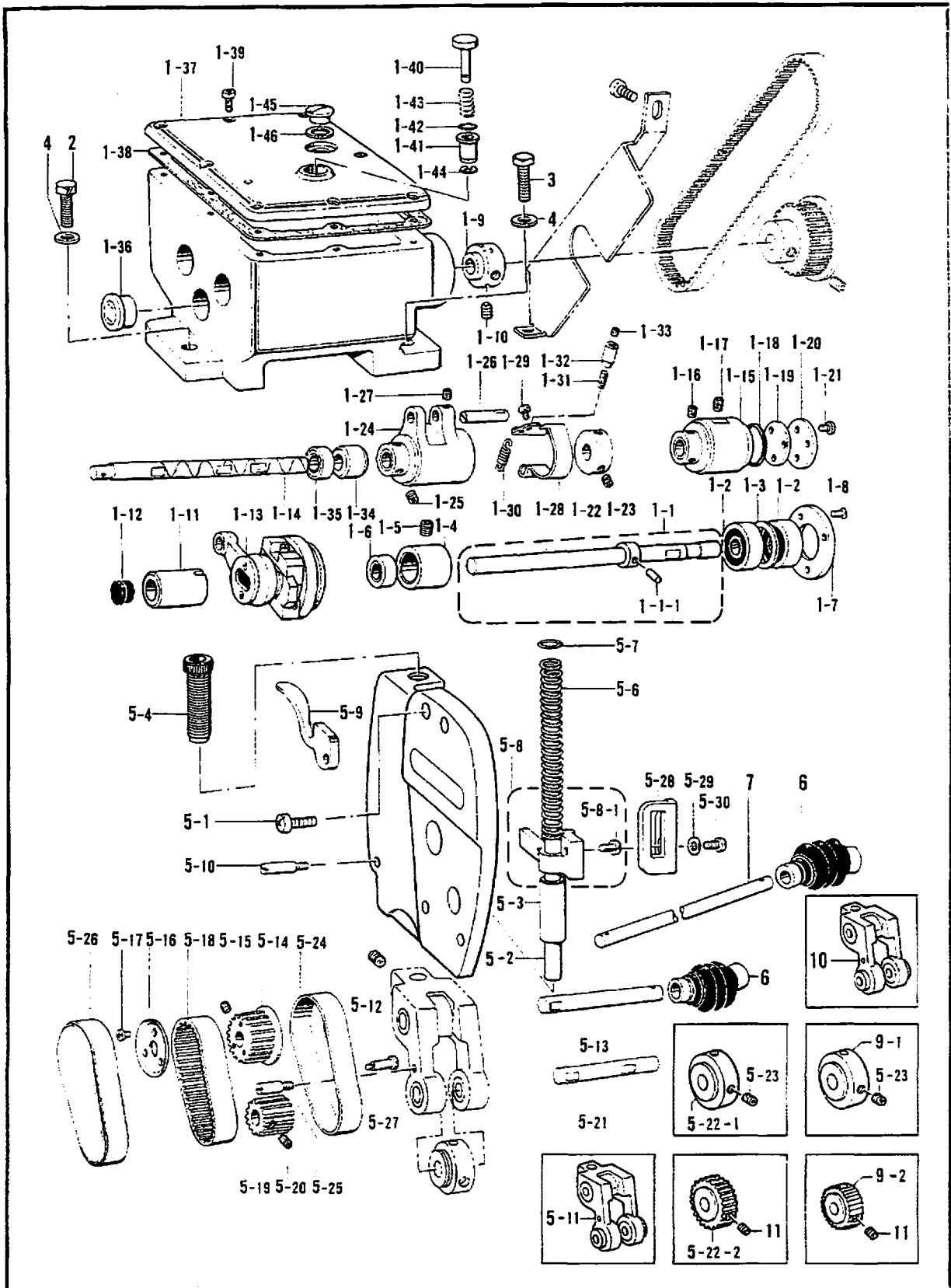

118-927-241

H. プーラ装置関係 (-7, -8) / Puller device mechanism (-7, -8) / Ziehvorrichtung (-7, -8)  
/ Mécanisme due puller (-7, -8) / Mecanismo del dispositivo de arrastre (-7, -8)

REF.NO.	CODE	QTY	ヒンメイ	NAME OF PARTS	RM
5-10	150705001	1	テコササエジク	SUPPORT STUD	
5-12	014770622	1	アナトメネジ6.35クボミ	SET SCREW, SOCKET (CP) SM6.35	
5-13	150711001	1	タイミングプーリジク	TIMING PULLEY SHAFT	
5-14	150712001	1	タイミングプーリクミ	TIMING PULLEY ASSY, C	
5-15	014680422	2	アナトメネジ4.37クボミ	SET SCREW, SOCKET (CP) SM4.37	
5-16	150715001	1	フランジB	FLANGE, B	
5-17	106568003	3	シメネジ3.57	SCREW, SM3.57	
5-18	150716001	1	プーラタイミングベルトB	PULLER TIMING BELT, B	
5-19	150717000	1	タイミングプーリD	TIMING PULLEY, D	
5-20	014680422	2	アナトメネジ4.37クボミ	SET SCREW, SOCKET (CP) SM4.37	
5-21	150718001	1	プーラジク	PULLER SHAFT	
5-24	150720001	1	カバーD	TIMING BELT COVER, D	
5-25	150721001	1	スタツド	STUD	
5-26	150722001	1	カバーU	TIMING BELT COVER, U	
5-27	150723001	1	ダンネジ3.57	SHOULDER SCREW, SM3.57	
5-28	153965001	1	プーラオサエボウアゲ	PULLER PRESSER BAR LIFTER	
5-29	025060232	1	ヒラザガネチユウ6	WASHER, PLAIN M 6	
5-30	062761012	1	ナベコ595-28X10	SCREW, PAN SM5.95-28X10	
6	150725001	2	カバーツギジギテ	UNIVERSAL JOINT ASSY	
7	150726001	1	ツギテジク	UNIVERSAL JOINT SHAFT	
-----					
10	S16488001	1	<B927用> プーラササエクミ	<FOR B927> PULLER SUPPORT ASSY	
5-11	150706001	1	<B928用> プーラササエクミ	<FOR B928> PULLER SUPPORT ASSY	
5-22-1	S06311201	1	<B927-7 3/16"用> プーラ	<FOR B927-7, 3/16"> PULLER	
5-23	014680622	2	アナトメネジ4.37クボミ	SET SCREW, SOCKET (CP) SM4.37	
5-22-2	S41315001	1	<B928用 -7, -8デニム仕様> プーラ	<For B927-7 1/4", -8 & B928 Heavy materials> PULLER	
11	014760622	2	アナトメネジ5.95	SET SCREW, SOCKET SM5.95	
9-1	154344201	1	<B927-7 1/4用,-8用, B928厚物用> プーラ	<For B927-7 1/4", -8 & B928 Heavy materials> PULLER	
5-23	014680422	2	アナトメネジ4.37クボミ	SET SCREW, SOCKET (CP) SM4.37	
9-2	150719001	1	<B928用 -8 1/8X2 国内用> プーラ	<For B928-8 1/8X2 Japan> PULLER	
11	014760622	2	アナトメネジ5.95	SET SCREW, SOCKET SM5.95	

118-927-241

J. 下軸関係 / Lower shaft mechanism / Untere Welle / Mécanisme de l'arbre inférieur / Mecanismo del eje inferior

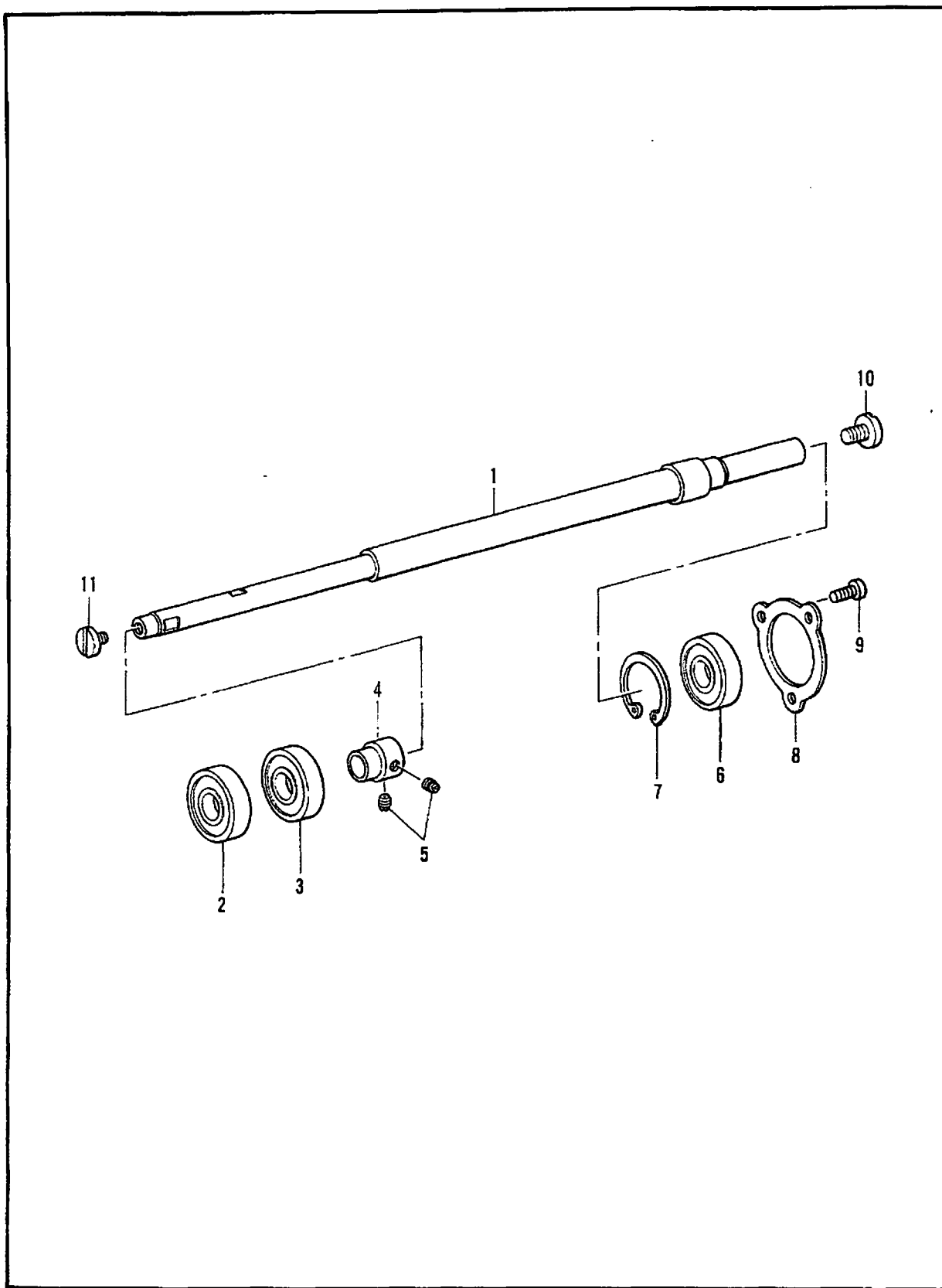

118-927-305

J. 下軸関係 / Lower shaft mechanism / Untere Welle / Mécanisme de l'arbre inférieur  
 / Mecanismo del eje inferior

REF.NO.	CODE	Q'TY	ヒンメイ	NAME OF PARTS	RM
1	105147101	1	シタジク	LOWER SHAFT	
2	072620070	1	タマジクウケ6200Z	BALL BEARING, 6200Z	
3	072620180	1	タマジクウケ6201ZZ	BALL BEARING, 6201ZZ	
4	105150000	1	タマジクウケブシユ	BALL BEARING BUSH	
5	102716004	2	トメネジ4.37	SET SCREW, SM4.37	
6	072630260	1	ベアリング6302VV	BALL BEARING, 6302VV	
7	048420242	1	トメワアナヨウC42	RETAINING RING, C42	
8	540316051	1	ベアリングオサエ	BEARING PRESSER	
9	062711012	3	ナベコ476-32X10	SCREW, PAN SM4.76-32X10	
10	105155001	1	シメネジ6.35	SCREW, SM6.35	
11	105156002	1	シメネジ4.37	SCREW, SM4.37	

118-927-305



K. ルーバー関係 / Looper mechanism / Greiter / Mécanisme des griffes  
 / Mecanismo del presilladora

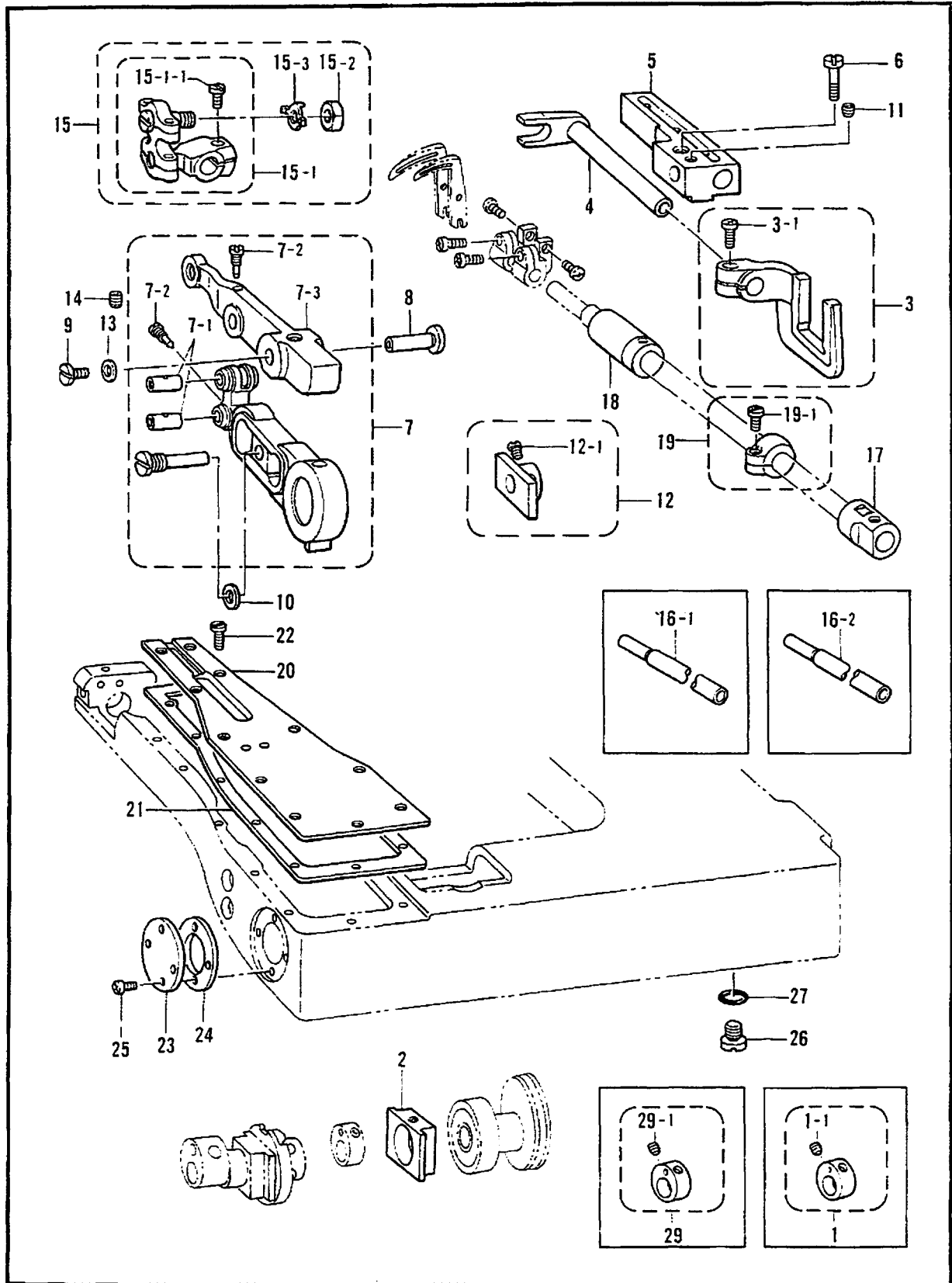

118-927-306

K. ルーバー関係 / Looper mechanism / Greifer / Mécanisme des griffes  
/ Mecanismo del presilladora

REF.NO.	CODE	Q'TY	ヒンメイ	NAME OF PARTS	RM
2	S40302000	1	ヘンシンリンスリーブ	ECCENTRIC WHEEL SLEEVE	
3	181993101	1	ゼンゴフタマタクミ	LOPPER FEEDING FORK ASSY	
3-1	105176001	1	シメネジ4.37	SCREW, SM4.37	
4	105177001	1	ゼンゴフタマタジク	LOOPER FEEDING FORK SHAFT	
5	105178100	1	ゼンゴフタマタジクウケ	LOPPER F/FORK SHAFT BRACKET	
6	105179001	1	シメネジ4.76	SCREW, SM4.76	
7	S40303001	1	ルーバレンカンクミ	LOPPER CONNECTING ROD ASSY	
7-1	105183001	2	ルーバリンクジク	LOOPER LINK SHAFT	
7-2	105184000	2	シメネジ2.38	SCREW, SM2.38	
7-3	S40792001	1	ルーハレバー	LOPPER LEVER	
8	S40793051	1	ルーバレバージュク	LOPPER LEVER SHAFT	
9	105191001	1	シメネジ4.37	SCREW, SM4.37	
10	081010870	1	OリングS10	O RING, S10	
11	100260001	1	トメネジ5.95	SET SCREW, SM5.95	
12	181987001	1	ルーバレンカンアンナイイタ	LOOPER CONNECT. ROD GUIDE ASSY	
12-1	100366001	2	マルヒラトメネジ4.37	SET SCREW, (FT) SM4.37	
13	081003670	1	OリングPW3	O RING, PW3	
14	014761030	1	アナクボミ595-28X10	SET SCREW, SOCKET (CP) SM5.95	
15	105193101	1	ルーバジクリンククミ	LOOPER SHAFT LINK ASSY SET	
15-1	183185101	1	ルーバジクリンククミ	LOOPER SHAFT LINK ASSY SET	
15-1-1	105176001	1	シメネジ4.37	SCREW, SM4.37	
15-2	100022004	1	ナツト5.95	NUT, SM5.95	
15-3	105198000	1	タマジクザガネ	WASHER	
17	105201000	1	ルーバジクメタルF	LOOPER SHAFT BUSH, F	
18	148877100	1	ルーバジクメタルB	LOOPER SHAFT BUSH, B	
19	181971001	1	ルーバジクセツトカラー	LOOPER SHAFT SET COLLAR	
19-1	062680812	1	ナベコ437-40X8	SCREW, PAN SM4.37-40X8	
20	S40306001	1	マエオクリウデフタ	FRONT FEED ARM CAP	
21	S40307001	1	マエオクリウデフタバツキン	PACKING	
22	105216001	11	シメネジ3.57	SCREW, SM3.57	
23	105217059	1	タマジクウケフタ	BALL BEARING	
24	S40308001	1	タマジクウケフタバツキン	PACKING	
25	062670512	4	ナベコ357-40X5	SCREW, PAN SM3.57-40X5	
26	140518001	1	シメネジ7.94	SCREW, SM7.94	
27	081007070	1	OリングP7	O RING, P7	
16-1	105200101	1	<B927 -8以外用> ルーバジク	<FOR B927 WITHOUT "-8"> LOPPER SHAFT	
16-2	S16490101	1	<B927 -8, B928用> ルーバジク	<FOR B927 "-8" & B928> LOOPER SHAFT	
1	181126001	1	<B927中厚物, B928用> ヘンシンリンネジツキ	<For B927 "Medium materials" & B928> ECCENTRIC WHEEL WITH SCREW	
1-1	153675001	2	アナトメネジ4.37	SET SCREW, SOCKET SM4.37	
29	S36862001	1	<B927薄物用> ヘンシンリンネジツキ	<FOR B927 THIN MATERIALS > ECCENTRIC WHEEL WITH SCREW	
29-1	153675001	2	アナトメネジ4.37	SET SCREW, SOCKET SM4.37	

118-927-306

L1. 上糸通シ関係 (B927) / Upper threading mechanism (B927) / Obererfadens (B927)  
 / Mécanisme de l'enfilage supérieur (B927) / Mecanismo del enhebrado superior (B927)

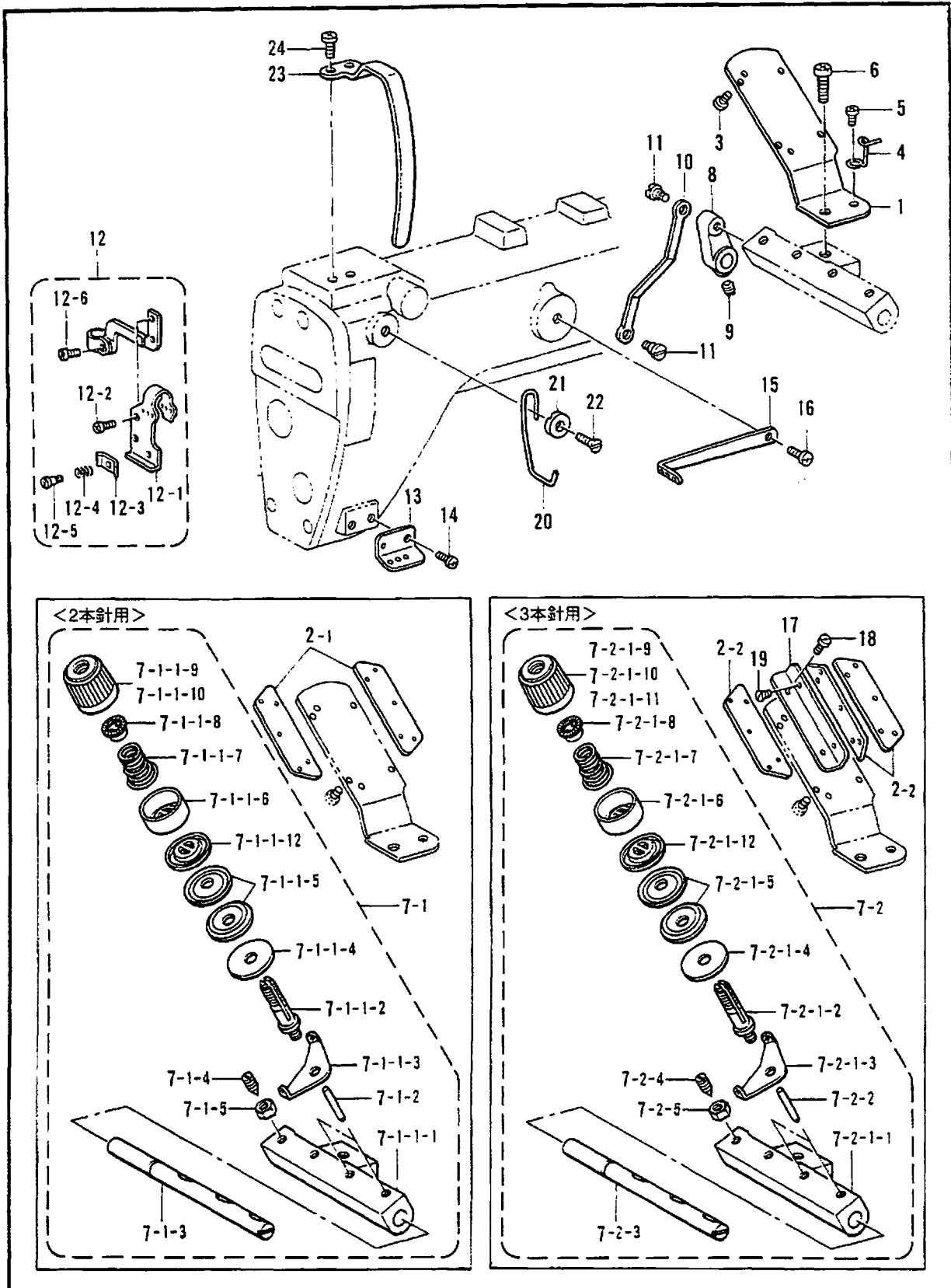

118-927-412

L1 . 上糸通シ関係 (B927) / Upper threading mechanism (B927) / Obererfadens (B927)  
 / Mécanisme de l'enfilage supérieur (B927) / Mecanismo del enhebrado superior (B927)

REF.NO.	CODE	Q'TY	ヒンメイ	NAME OF PARTS	RM
1	111070109	1	ウワイトアンナイダイ	UPPER THREAD GUIDE	
3	062630412	4	ナベコ238-56X4	SCREW, PAN SM2.38-56X4	
4	105222001	1	ウワイトアンナイダイイトカケ	THREAD GUIDE	
5	062670512	1	ナベコ357-40X5	SCREW, PAN SM3.57-40X5	
6	062712012	1	ナベコ476-32X20	SCREW, PAN SM4.76-32X20	
8	105235251	1	イトユルメウデ	TENSION RELEASE CRANK	
9	151602002	1	トメネジ4.37	SET SCREW, SM4.37	
10	105236001	1	イトユルメレンカン	TENSION RELEASE CONNECTING ROD	
11	105237002	2	ダンネジ3.57	SHOULDER SCREW, SM3.57	
12	S40310001	1	ウワイトテンピンクミ	UPPER THREAD TAKE-UP ASSY	
12-1	S40312001	1	ウワイトテンピンイトトオシ	UPPER THREAD GUIDE	
12-2	062660512	2	ナベコ318-40X5	SCREW, PAN SM3.18X5	
12-3	105243001	1	ウワイトテンピンイトオサエ	UPPER THREAD TAKE-UP HOLDER	
12-4	105244000	1	テンピンイトオサエバネ	SPRING	
12-5	105245001	1	ダンネジ2.38	SHOULDER SCREW, SM2.38	
12-6	100064005	1	シメネジ3.57	SCREW, SM3.57	
13	S40313051	1	ハライトイトアンナイ	UPPER THREAD GUIDE	
14	062670712	1	ナベコ357-40X7	SCREW, PAN SM3.57-40X7	
15	111077001	1	イトユルメレバー	TENSION RELEASE LEVER	
16	060670812	1	バインド357-40X8	SCREW, BIND SM3.57-40X8	
20	111083001	1	ウワイトテンピンイトカケ	UPPER THREAD TAKE-UP GUIDE	
21	111188001	1	イトアンナイザガネ	WASHER	
22	111084001	1	サラネジ3.57	SCREW, FLAT SM3.57	
23	S37186001	1	テンピンカバー	THREAD TAKE-UP COVER	
24	062710812	2	ナベコ476-32X8	SCREW, PAN SM4.76-32X8	
-----					
2-1	105221001	2	<2本針用> ミツメイトカケ	<FOR TWIN NEEDLE> THREAD RETAINER	
7-1	S43446009	1	ウワイトチヨウシクミ	UPPER THREAD REGULATOR ASSY	
7-1-1-1	111075059	1	ウワイトチヨウシボウダイ	UPPER THREAD TENSION BRACKET	
7-1-1-2	145440001	2	イトチヨウシボウ	TENSION STUD	
7-1-1-3	110813001	2	ハライトアンナイ	NEEDLE THREAD GUIDE	
7-1-1-4	110832009	2	イトチヨウシサラフェルト	TENSION DISC FELT	
7-1-1-5	145446001	4	イトチヨウシサラ	TENSION DISC	
7-1-1-6	144103009	2	イトチヨウシサラオサエ	TENSION DISC PRESSER	
7-1-1-7	144104001	2	ハライトチヨウシバネ	THREAD TENSION ADJUST SPRING	
7-1-1-8	S30564000	2	チヨウシバネウエザガネ	TENSION SPRING WASHER	
7-1-1-9	S30565002	1	イトチヨウシナツトミドリ	TENSION NUT, GREEN	
7-1-1-10	S30565003	1	イトチヨウシナツトアカ	TENSION NUT, RED	
7-1-1-12	159805001	2	イトチヨウシサラオサエ	TENSION DISC PRESSER	
7-1-2	105231000	2	イトユルメヒン	PIN	
7-1-3	111076151	1	イトユルメジク	TENSION RELEASE SHAFT	
7-1-4	105233002	1	トメネジ4.37	SET SCREW, SM4.37	
7-1-5	105234003	1	ナツト4.37	NUT, SM4.37	
-----					
2-2	105221001	3	<3本針用> ミツメイトカケ	<FOR THREE NEEDLE> THREAD RETAINER	
7-2	S43448009	1	ウワイトチヨウシクミ	UPPER THREAD REGULATOR ASSY	
7-2-1-1	111075059	1	ウワイトチヨウシボウダイ	UPPER THREAD TENSION BRACKET	
7-2-1-2	145440001	3	イトチヨウシボウ	TENSION STUD	
7-2-1-3	110813001	3	ハライトアンナイ	NEEDLE THREAD GUIDE	
7-2-1-4	110832009	3	イトチヨウシサラフェルト	TENSION DISC FELT	
7-2-1-5	145446001	6	イトチヨウシサラ	TENSION DISC	
7-2-1-6	144103009	3	イトチヨウシサラオサエ	TENSION DISC PRESSER	
7-2-1-7	144104001	3	ハライトチヨウシバネ	THREAD TENSION ADJUST SPRING	
7-2-1-8	S30564000	3	チヨウシバネウエザガネ	TENSION SPRING WASHER	
7-2-1-9	S30565002	1	イトチヨウシナツトミドリ	TENSION NUT, GREEN	

118-927-412

L1 . 上糸通シ関係 (B927) / Upper threading mechanism (B927) / Obererfadens (B927)  
 / Mécanisme de l'enfilage supérieur (B927) / Mecanismo del enhebrado superior (B927)

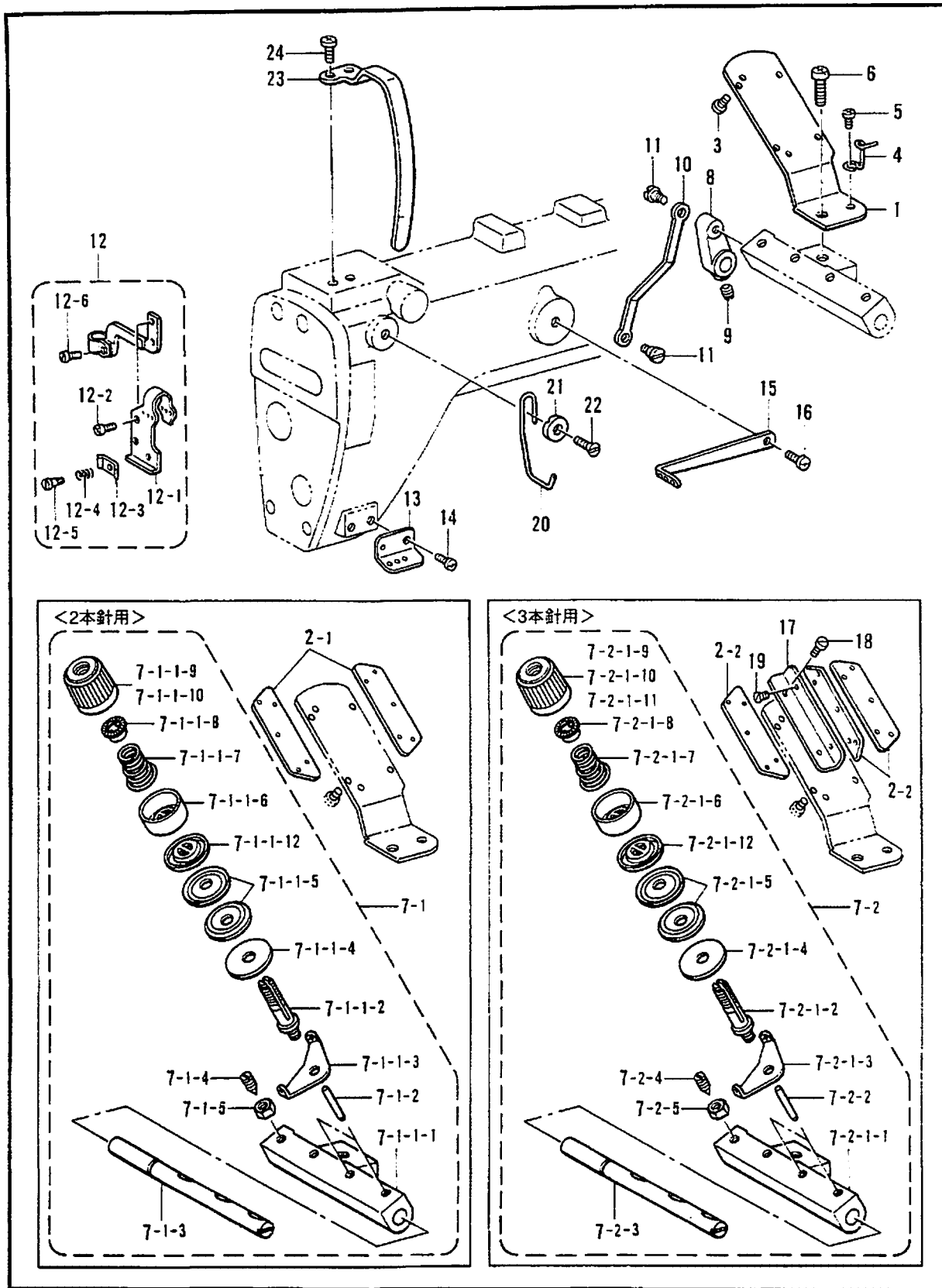

118-927-412

L1 . 上糸通シ関係 (B927) / Upper threading mechanism (B927) / Obererfadens (B927)  
 / Mécanisme de l'enfilage supérieur (B927) / Mecanismo del enhebrado superior (B927)

REF.NO.	CODE	Q'TY	ヒンメイ	NAME OF PARTS	RM
7-2-1-10	S30565003	1	イトチヨウシナツトアカ	TENSION NUT, RED	
7-2-1-11	S30565004	1	イトチヨウシナツトキイ	TENSION NUT, YELLOW	
7-2-1-12	159805001	3	イトチヨウシサラオサエ	TENSION DISC PRESSER	
7-2-2	105231000	3	イトユルメピン	PIN	
7-2-3	111076151	1	イトユルメジク	TENSION RELEASE SHAFT	
7-2-4	105233002	1	トメネジ4.37	SET SCREW, SM4.37	
7-2-5	105234003	1	ナツト4.37	NUT, SM4.37	
17	111072009	1	ミツメイトアンナイトリツケイタ	THREAD GUIDE SET PLATE	
18	062630412	2	ナベコ238-56X4	SCREW, PAN SM2.38-56X4	
19	111073001	2	サラネジ2.38	SCREW, FLAT SM2.38	

118-927-412

L2 . 上糸通シ関係 (B928) / Upper threading mechanism (B928) / Obererfadens (B928)  
 / Mécanisme de l'enfilage supérieur (B928) / Mecanismo del enhebrado superior (B928)

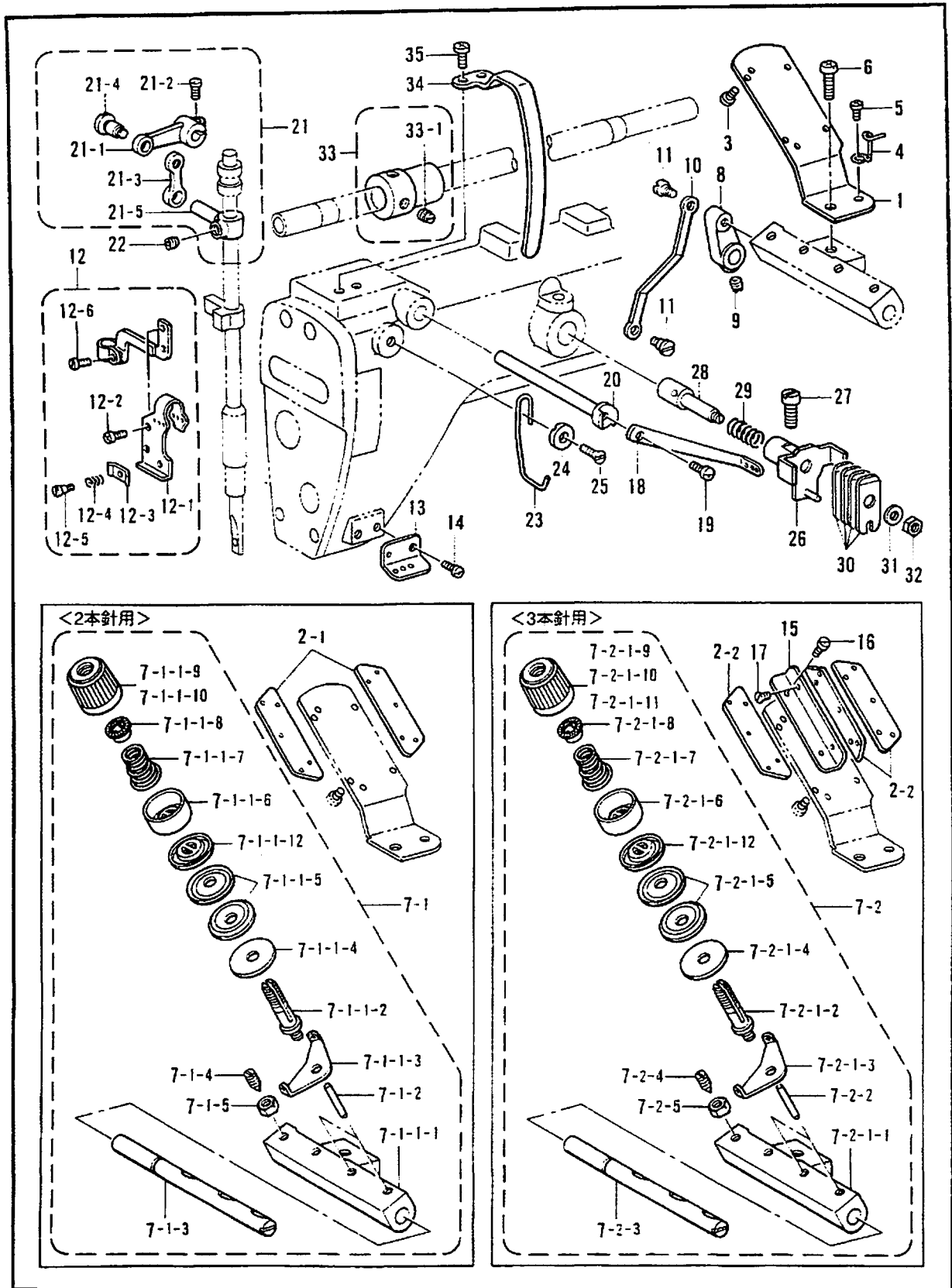

118-928-412



L2 . 上糸通シ関係 (B928) / Upper threading mechanism (B928) / Obererfadens (B928)  
 / Mécanisme de l'enfilage supérieur (B928) / Mecanismo del enhebrado superior (B928)

REF.NO.	CODE	Q'TY	ヒンメイ	NAME OF PARTS	RM
1	111070109	1	ウワイトアンナイダイ	UPPER THREAD GUIDE	
3	062630412	4	ナベコ238-56X4	SCREW, PAN SM2.38-56X4	
4	105222001	1	ウワイトアンナイダイイトカケ	THREAD GUIDE	
5	062670512	1	ナベコ357-40X5	SCREW, PAN SM3.57-40X5	
6	062712012	1	ナベコ476-32X20	SCREW, PAN SM4.76-32X20	
8	105235251	1	イトユルメウデ	TENSION RELEASE CRANK	
9	151602002	1	トメネジ4.37	SET SCREW, SM4.37	
10	105236001	1	イトユルメレンカン	TENSION RELEASE CONNECTING ROD	
11	105237002	2	ダンネジ3.57	SHOULDER SCREW, SM3.57	
12	540310001	1	ウワイトテンビンクミ	UPPER THREAD TAKE-UP ASSY	
12-1	540312001	1	ウワイトテンビンイトトオシ	UPPER THREAD GUIDE	
12-2	062660512	2	ナベコネジ318-40X5	SCREW, PAN SM3.18-40X5	
12-3	105243001	1	ウワイトテンビンイトオサエ	UPPER THREAD TAKE-UP HOLDER	
12-4	105244000	1	テンビンイトオサエバネ	SPRING	
12-5	105245001	1	ダンネジ2.38	SHOULDER SCREW, SM2.38	
12-6	100064005	1	シメネジ3.57	SCREW, SM3.57	
13	540313051	1	ハリイトイトアンナイ	UPPER THREAD GUIDE	
14	062670712	1	ナベコ357-40X7	SCREW, PAN SM3.57-40X7	
18	111077001	1	イトユルメレバー	TENSION RELEASE LEVER	
19	060670612	1	バインド357-40X6	SCREW, BIND SM3.57-40X6	
20	111078051	1	イトユルメレバージク	TENSION RELEASE LEVER SHAFT	
21	111506101	1	イトユルメレンカンクミ	T/RELEASE CONNECTING ROD ASSY	
21-1	111079001	1	イトユルメレンカン	TENSION RELEASE CONNECTING ROD	
21-2	100064005	1	シメネジ3.57	SCREW, SM3.57	
21-3	149011051	1	イトユルメリンク	TENSION RELEASE LINK	
21-4	115132002	1	ダンネジ4.76	SHOULDER SCREW, M4.76	
21-5	111082051	1	イトユルメスタッド	TENSION RELEASE STUD	
22	013760610	1	トメネジ5.95クボミ	SET SCREW, (CP) SM5.95	
23	111083001	1	ウワイトテンビンイトカケ	UPPER THREAD TAKE-UP GUIDE	
24	111188001	1	イトアンナイザガネ	WASHER	
25	111084001	1	サラネジ3.57	SCREW, FLAT SM3.57	
26	111089001	1	ウワイトシメチヨウシダイ	UPPER THREAD TENSION BRACKET	
27	105073001	1	アタマツキトメネジ5.95	SET SCREW, SOCKET SM5.95	
28	111189001	1	ウワイトシメボウクミ	UPPER THREAD STUD ASSY	
29	111093001	1	ウワイトシメオシバネ	SPRING	
30	105277001	4	シタイトチヨウシイタ	LOWER THREAD TENSION PLATE	
31	100645003	1	ザガネ	WASHER	
32	105234003	1	ナツト4.37	NUT, SM4.37	
33	181060001	1	ウワイトシメカムネジツキ	UPPER THREAD CAM WITH SCREW	
33-1	100058003	2	トメネジ5.95	SET SCREW, SM5.95	
34	537186001	1	テンビンカバー	THREAD TAKE-UP COVER	
35	062710812	2	ナベコ476-32X8	SCREW, PAN SM4.76-32X8	
-----					
2-1	105221001	2	<2本針用> ミツメイトカケ	<FOR TWIN NEEDLE> THREAD RETAINER	
7-1	541316009	1	ウワイトチヨウシクミ	UPPER THREAD REGULATOR ASSY	
7-1-1-1	111075059	1	ウワイトチヨウシボウダイ	UPPER THREAD TENSION BRACKET	
7-1-1-2	145440001	2	イトチヨウシボウ	TENSION STUD	
7-1-1-3	110813001	2	ハリイトアンナイ	NEEDLE THREAD GUIDE	
7-1-1-4	110832009	2	イトチヨウシサラフェルト	TENSION DISC FELT	
7-1-1-5	145446001	4	イトチヨウシサラ	TENSION DISC	
7-1-1-6	144103009	2	イトチヨウシサラオサエ	TENSION DISC PRESSER	
7-1-1-7	148851001	2	ハリイトチヨウシバネ	THREAD TENSION ADJUST SPRING	
7-1-1-8	530564000	2	チヨウシバネウエザガネ	TENSION SPRING WASHER	
7-1-1-9	530565002	1	イトチヨウシナツトミドリ	TENSION NUT, GREEN	
7-1-1-10	530565003	1	イトチヨウシナツトアカ	TENSION NUT, RED	
7-1-1-12	159805001	2	イトチヨウシサラオサエ	TENSION DISC PRESSER	
7-1-2	105231000	2	イトユルメピン	PIN	

118-928-412



L2 . 上糸通ノ機構 (8928) / Upper threading mechanism (8928) / Obererradens (8928)  
 / Mécanisme de l'enfilage supérieur (8928) / Mecanismo del enhebrado superior (8928)

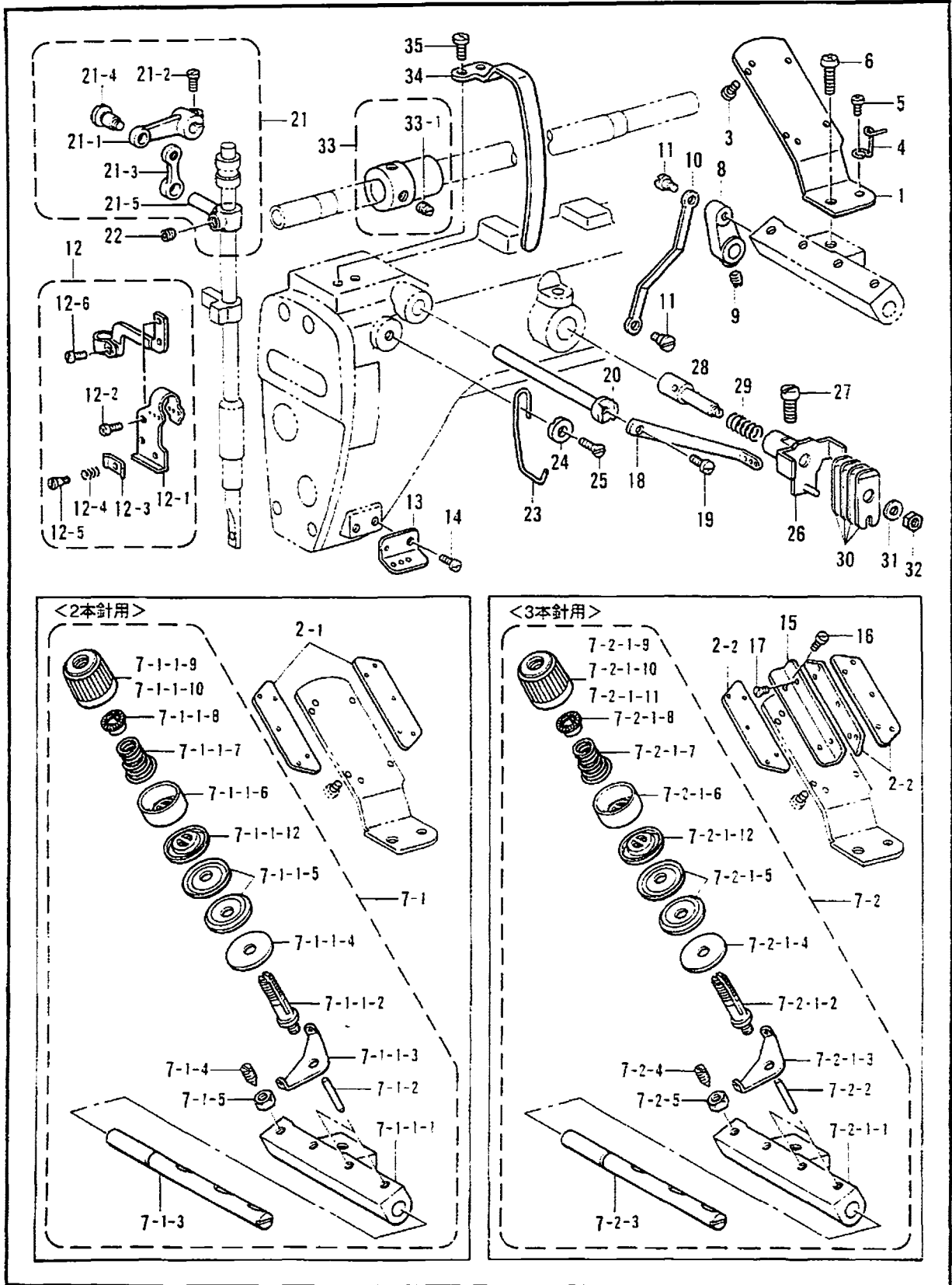

118-928-412

L2 . 上糸通シ関係 (B928) / Upper threading mechanism (B928) / Obererfadens (B928)  
 / Mécanisme de l'enfilage supérieur (B928) / Mecanismo del enhebrado superior (B928)

REF.NO.	CODE	Q'TY	ヒンメイ	NAME OF PARTS	RM
7-1-3	111076151	1	イトユルメジク	TENSION RELEASE SHAFT	
7-1-4	105233002	1	トメネジ4.37	SET SCREW, SM4.37	
7-1-5	105234003	1	ナツト4.37	NUT, SM4.37	
			<3本針用>	<FOR THREE NEEDLE>	
2-2	105221001	3	ミツメイトカケ	THREAD RETAINER	
7-2	S41318009	1	ウワイトチヨウシクミ	UPPER THREAD REGULATOR ASSY	
7-2-1-1	111075059	1	ウワイトチヨウシボウダイ	UPPER THREAD TENSION BRACKET	
7-2-1-2	145440001	3	イトチヨウシボウ	TENSION STUD	
7-2-1-3	110813001	3	ハリイトアンナイ	NEEDLE THREAD GUIDE	
7-2-1-4	110832009	3	イトチヨウシサラフェルト	TENSION DISC FELT	
7-2-1-5	145446001	6	イトチヨウシサラ	TENSION DISC	
7-2-1-6	144103009	3	イトチヨウシサラオサエ	TENSION DISC PRESSER	
7-2-1-7	148851001	3	ハリイトチヨウシバネ	THREAD TENSION ADJUST SPRING	
7-2-1-8	S30564000	3	チヨウシバネウエザガネ	TENSION SPRING WASHER	
7-2-1-9	S30565002	1	イトチヨウシナツトミドリ	TENSION NUT, GREEN	
7-2-1-10	S30565003	1	イトチヨウシナツトアカ	TENSION NUT, RED	
7-2-1-11	S30565004	1	イトチヨウシナツトキイ	TENSION NUT, YELLOW	
7-2-1-12	159805001	3	イトチヨウシサラオサエ	TENSION DISC PRESSER	
7-2-2	105231000	3	イトユルメピン	PIN	
7-2-3	111076151	1	イトユルメジク	TENSION RELEASE SHAFT	
7-2-4	105233002	1	トメネジ4.37	SET SCREW, SM4.37	
7-2-5	105234003	1	ナツト4.37	NUT, SM4.37	
15	111072009	1	ミツメイトアンナイトリツケイタ	THREAD GUIDE SET PLATE	
16	062630412	2	ナベコ238-56X4	SCREW, PAN SM2.38-56X4	
17	111073001	2	サラネジ2.38	SCREW, FLAT SM2.38	

118-928-412

M1. 下糸通シ関係 (B927) / Lower threading mechanism (B927) / Untererfadens (B927)  
 / Mécanisme de l'enfilage inférieur (B927) / Mecanismo de le enhebrado inferior (B927)

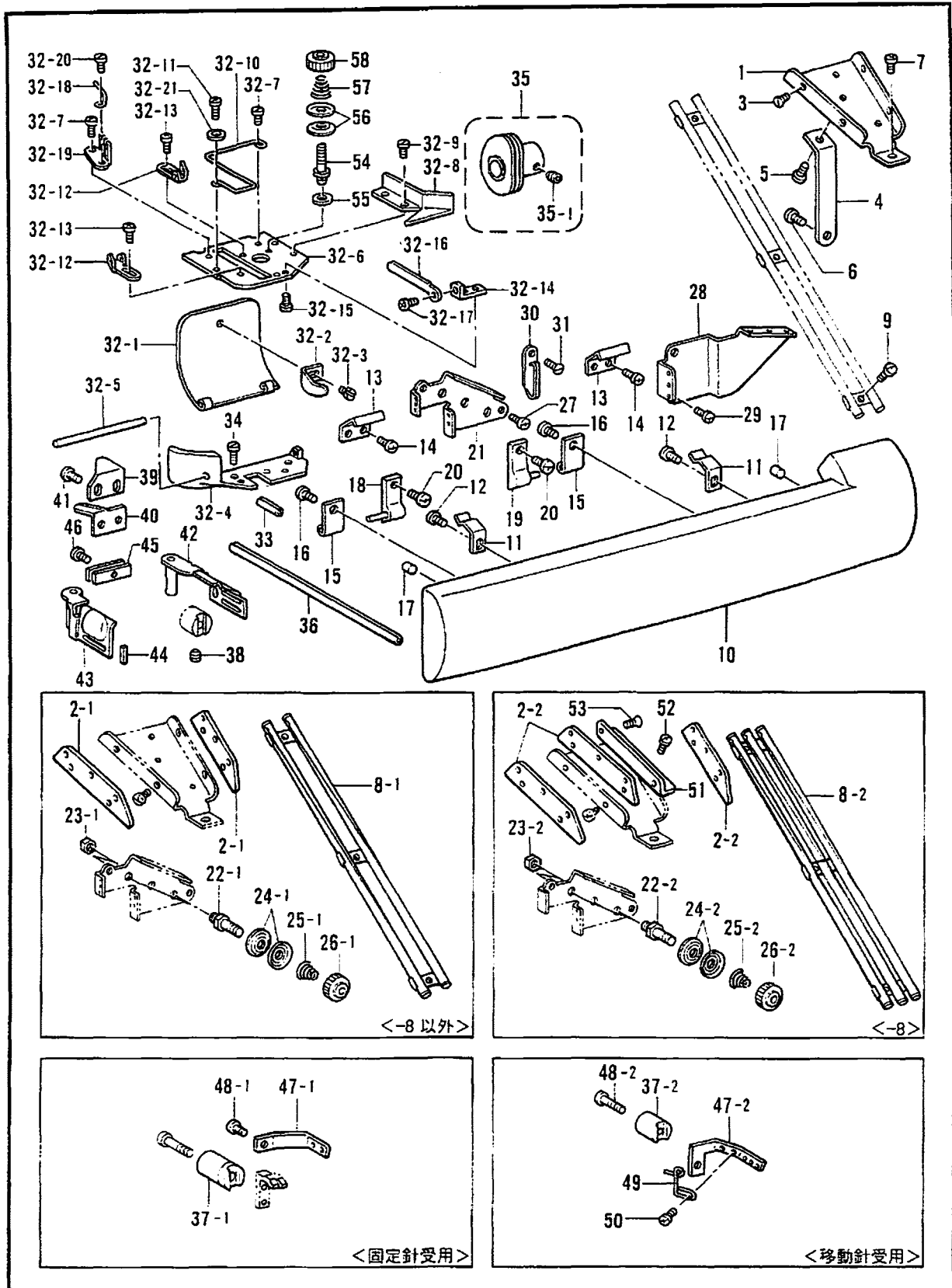

118-927-413

M1. 下糸通シ関係 (B927) / Lower threading mechanism (B927) / Untererfadens (B927)  
 / Mécanisme de l'enfilage inférieur (B927) / Mecanismo de le enhebrado inferior (B927)

REF.NO.	CODE	Q'TY	ヒンメイ	NAME OF PARTS	RM
1	111095009	1	シタイトアンナイダイ	LOWER THREAD GUIDE RETAINER	
3	111073001	4	サラネジ2.38	SCREW, FLAT SM2.38	
4	111096009	1	シタイトアンナイササエ	LOWER THREAD GUIDE SUPPORT	
5	062670412	1	ナベコ357-40X4	SCREW, PAN SM3.57-40X4	
6	062670512	1	ナベコ357-40X5	SCREW, PAN SM3.57-40X5	
7	062671012	1	ナベコ357-40X10	SCREW, PAN SM3.57-40X10	
9	062670812	3	ナベコ3.57-40X8	SCREW, PAN SM3.57-40X8	
10	S40319001	1	マエカパー	FRONT COVER	
11	S40320051	2	マエカパートメバネ	FRONT COVER SPRING	
12	060670512	2	バインド357-40X5	SCREW, BIND SM3.57-40X5	
13	S40321051	2	マエカパーフック	FRONT COVER HOOK	
14	062670612	4	ナベコ357-40X6	SCREW, PAN SM3.57-40X6	
15	S40322051	2	マエカパーヒンジ	HINGE	
16	062670612	2	ナベコ357-40X6	SCREW, PAN SM3.57-40X6	
17	142274009	2	ゴムセン4.2	RUBBER CAP, 4.2	
18	105257009	1	アンナイフタヒンジLクミ	L/THREAD GUIDE HINGE ASSY, L	
19	105260009	1	アンナイフタヒンジRクミ	L/THREAD GUIDE HINGE ASSY, R	
20	062671012	2	ナベコ357-40X10	SCREW, PAN SM3.57-40X10	
21	S40323001	1	シタイトチヨウシダイ	LOWER THREAD TENSION BRACKET	
27	062670612	2	ナベコ357-40X6	SCREW, PAN SM3.57-40X6	
28	S40325001	1	シタイトアンナイ	LOWER THREAD GUIDE	
29	062670612	2	ナベコ357-40X6	SCREW, PAN SM3.57-40X6	
30	112658001	1	アームイトアンナイM	ARM THREAD GUIDE, M	
31	108960002	1	サラネジ3.57	SCREW, FLAT SM3.57	
32	S40266051	1	シタイトテンビンダイクミ	LOWER THREAD TAKE-UP BRACKET	
32-1	105280009	1	シタイトテンビンフタ	L/THREAD TAKE-UP LEVER COVER	
32-2	105281001	1	テンビンフタトメメタバネ	SPRING, PLATE	
32-3	122771002	1	シメネジ2.38	SCREW, SM2.38	
32-4	105284101	1	シタイトテンビンダイササエ	L/TR. TAKE-UP LEVER BRACKET	
32-5	105285000	1	シタイトテンビンフタジク	L/TR. TAKE-UP LEVER COV. SHAFT	
32-6	S40326051	1	シタイトテンビンダイ	L/TR. TAKE-UP LEVER BRACKET	
32-7	062670612	2	ナベコ357-40X6	SCREW, PAN SM3.57-40X6	
32-8	105287001	1	テンビンダイアンナイイタ	GUIDE PLATE	
32-9	105288001	2	シメネジ2.38	SCREW, SM2.38	
32-10	S40327051	1	テンビンイトウケ	LOWER THREAD GUIDE	
32-11	060660416	1	バインド318-40X4	SCREW, BIND SM3.18-40X4	
32-12	S40795101	2	DLテンビンイトアンナイ	LOWER THREAD GUIDE	
32-13	060660416	2	バインド318-40X4	SCREW, BIND SM3.18-40X4	
32-14	S40328051	1	イトオサエドダイ	THREAD RELEASE BASE	
32-15	062660412	2	ナベコ318-40X4	SCREW, PAN SM3.18-40X4	
32-16	S40329051	1	テンビンイトオサエ	LOWER THREAD PRESSER	
32-17	062660412	1	ナベコ318-40X4	SCREW, PAN SM3.18-40X4	
32-18	105296001	1	テンビンダイイトカケ	THREAD GUIDE	
32-19	111112001	1	シタイトイトアンナイイタ	LOWER THREAD GUIDE PLATE	
32-20	105288001	1	シメネジ2.38	SCREW, SM2.38	
32-21	026030136	1	ヒラザガネコガタ3	WASHER, PLAIN S 3	
33	047501242	1	スプリングピンAW5	PIN, SPRING ROLL AW5	
34	100064005	2	シメネジ3.57	SCREW, SM3.57	
35	S40330051	1	シタイトテンビンネジツキM	LOWER THREAD TAKE-UP W/S, M	
35-1	014680422	2	アナトメネジ4.37クボミ	SET SCREW, SOCKET (CP) SM4.37	
36	105300101	1	シタイトオクリダシアンナイ	LOWER THREAD FEED BAR GUIDE	
38	013760610	1	トメネジ5.95クボミ	SET SCREW, (CP) SM5.95	
39	111113101	1	イトキリアンナイイタ	THREAD TRIMMER GUIDE PLATE	
40	111114101	1	イトキリ	THREAD TRIMMER	
41	062670612	2	ナベコ357-40X6	SCREW, PAN SM3.57-40X6	
42	S40335051	1	ルーバガワフタRA	LOOPER COVER, RA	
43	S40338051	1	ルーバガワフタLA	LOOPER COVER, LA	
44	047200842	1	スプリングピンAW2	PIN, SPRING ROLL AW2	
45	S40799051	2	ルーバガワフタトメバネ	SPRING	

118-927-413

M1. 下糸通シ関係 (B927) / Lower threading mechanism (B927) / Untererfadens (B927)  
 / Mécanisme de l'enfilage inférieur (B927) / Mecanismo de le enhebrado inferior (B927)

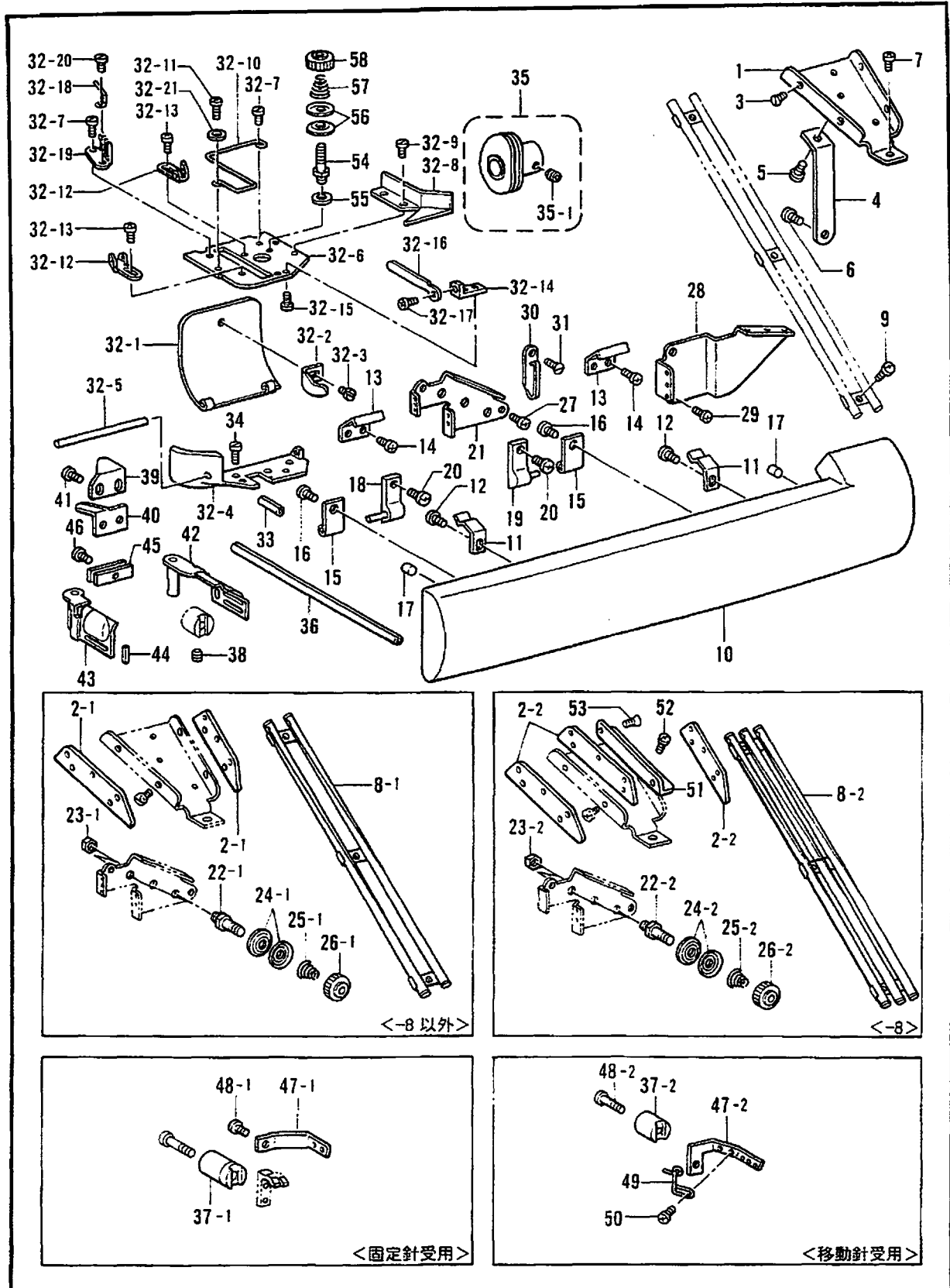

118-927-413

M1. 下糸通シ関係 (B927) / Lower threading mechanism (B927) / Untererfadens (B927)  
 / Mécanisme de l'enfilage inférieur (B927) / Mecanismo de le enhebrado inferior (B927)

REF.NO.	CODE	Q'TY	ヒンメイ	NAME OF PARTS	RM
46	062670712	1	ナベコ357-40X7	SCREW, PAN SM3.57-40X7	
54	S08987001	1	イトチヨウシボウ	THREAD TENSION CONTROL STUD	
55	146354001	1	ワガネ	WASHER, PLAIN 5	
56	144504001	2	イトアンナイサラ	THREAD GUIDE DISC	
57	S40324001	1	イトアンナイバネ	THREAD GUIDE SPRING	
58	155510001	1	イトチヨウシナツト	TENSION NUT	
-----					
2-1	105221001	2	<-8 以外用> ミツメイトカケ	<FOR WITHOUT "-8"> THREAD RETAINER	
8-1	105251009	1	シタイトタテアンナイクミ	INGLINED GUIDE TUBE ASSY	
22-1	S08987001	2	イトチヨウシボウ	THREAD TENSION CONTROL STUD	
23-1	021680202	2	ナツト2シユ4.37	NUT, 2 SM4.37	
24-1	144504001	4	イトアンナイサラ	THREAD GUIDE DISC	
25-1	S40324001	2	イトアンナイバネ	THREAD GUIDE SPRING	
26-1	155510001	2	イトチヨウシナツト	TENSION NUT	
2-2	105221001	3	<-8用> ミツメイトカケ	<FOR "-81"> THREAD RETAINER	
8-2	111097009	1	シタイトタテアンナイクミ	INGLINED GUIDE TUBE ASSY	
22-2	S08987001	3	イトチヨウシボウ	THREAD TENSION CONTROL STUD	
23-2	021680202	3	ナツト2シユ4.37	NUT, 2 SM4.37	
24-2	144504001	6	イトアンナイサラ	THREAD GUIDE DISC	
25-2	S40324001	3	イトアンナイバネ	THREAD GUIDE SPRING	
26-2	155510001	3	イトチヨウシナツト	TENSION NUT	
51	111072009	1	ミツメイトアンナイトリツケイタ	THREAD GUIDE SET PLATE	
52	062630412	2	ナベコ238-56X4	SCREW, PAN SM2.38-56X4	
53	111073001	2	サラネジ2.38	SCREW, FLAT SM2.38	
-----					
37-1	105301001	1	<固定針受用> ルーハイトアンナイダイ	<FOR "FIX NEEDLE SUPPORT"> LOOPER THREAD GUIDE BRACKET	
47-1	105304001	1	ルーハイトアンナイ	LOOPER THREAD GUIDE	
48-1	062660612	1	ナベコ318-40X6	SCREW, PAN SM3.18-40X6	
37-2	147291001	1	<移動針受用> ルーハイトアンナイダイ	<FOR "MOVEABLE NEEDLE SUPPORT"> LOOPER THREAD GUIDE BRACKET	
47-2	S16487151	1	ルーハイトアンナイ-8	LOOPER THREAD GUIDE, -8	
48-2	062671412	1	ナベコ357-40X14	SCREW, PAN SM3.57-40X14	
49	S40341001	1	ルーハイトアンナイ	LOOPER THREAD GUIDE	
50	062630412	2	ナベコ238-56X4	SCREW, PAN SM2.38-56X4	

118-927-413



M2. 下糸通シ関係 (B928) / Lower threading mechanism (B928) / Unterefadens (B928)  
 / Mécanisme de l'enfilage inférieur (B928) / Mecanismo de le enhebrado inferior (B928)

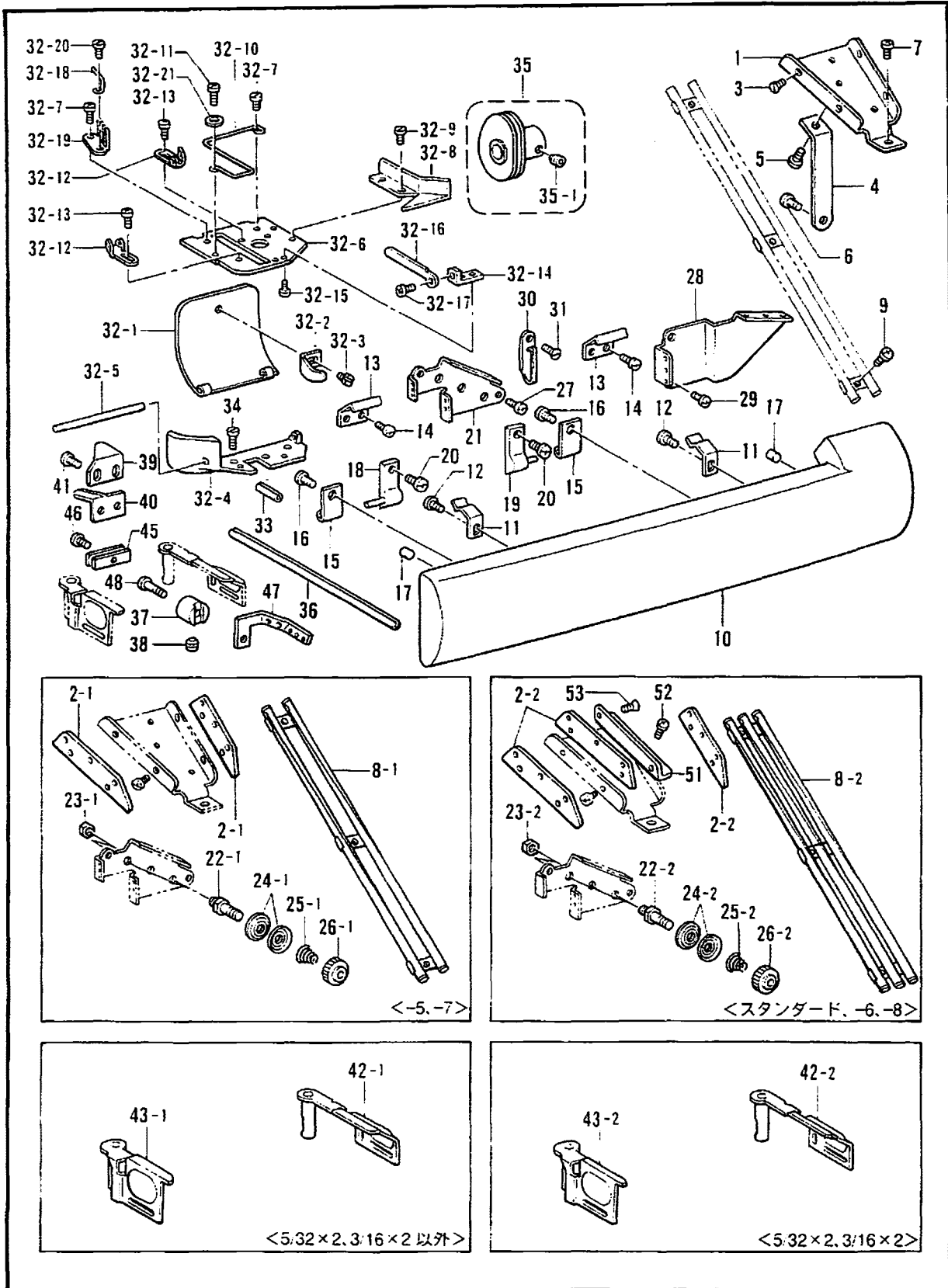

118-928-413

M2 . 下糸通シ関係 (B928) / Lower threading mechanism (B928) / Untererfadens (B928)  
 / Mécanisme de l'enfilage inférieur (B928) / Mecanismo de le enhebrado inferior (B928)

REF.NO.	CODE	QTY	ヒンメイ	NAME OF PARTS	RM
1	111095009	1	シタイトアンナイダイ	LOWER THREAD GUIDE RETAINER	
3	111073001	4	サラネジ2.38	SCREW, FLAT SM2.38	
4	111096009	1	シタイトアンナイササエ	LOWER THREAD GUIDE SUPPORT	
5	062670412	1	ナベコ357-40X4	SCREW, PAN SM3.57-40X4	
6	062670512	1	ナベコ357-40X5	SCREW, PAN SM3.57-40X5	
7	062671012	1	ナベコ357-40X10	SCREW, PAN SM3.57-40X10	
9	062670812	3	ナベコ3.57-40X8	SCREW, PAN SM3.57-40X8	
10	540319001	1	マエカバー	FRONT COVER	
11	540320051	2	マエカバートメバネ	FONT COVER SPRING	
12	060670512	2	バインド357-40X5	SCREW, BIND SM3.57-40X5	
13	540321051	2	マエカバーフック	FRONT COVER HOOK	
14	062670612	4	ナベコ357-40X6	SCREW, PAN SM3.57-40X6	
15	540322051	2	マエカバーヒンジ	HINGE	
16	062670612	2	ナベコ357-40X6	SCREW, PAN SM3.57-40X6	
17	142274009	2	ゴムセン4.2	RUBBER CAP, 4.2	
18	105257009	1	アンナイフタヒンジLクミ	L/THREAD GUIDE HINGE ASSY, L	
19	105260009	1	アンナイフタヒンジRクミ	L/THREAD GUIDE HINGE ASSY, R	
20	062671012	2	ナベコ357-40X10	SCREW, PAN SM3.57-40X10	
21	540323001	1	シタイトチヨウシダイ	LOWER THREAD TENSION BRACKET	
27	062670612	2	ナベコ357-40X6	SCREW, PAN SM3.57-40X6	
28	540325001	1	シタイトアンナイ	LOWER THREAD GUIDE	
29	062670612	2	ナベコ357-40X6	SCREW, PAN SM3.57-40X6	
30	112658001	1	アームイトアンナイM	ARM THREAD GUIDE, M	
31	108960002	1	サラネジ3.57	SCREW, FLAT SM3.57	
32	540266051	1	シタイトテンビンダイクミ	LOWER THREAD TAKE-UP BRACKET	
32-1	105280009	1	シタイトテンビンフタ	L/THREAD TAKE-UP LEVER COVER	
32-2	105281001	1	テンビンフタトメイタバネ	SPRING, PLATE	
32-3	122771002	1	シメネジ2.38	SCREW, SM2.38	
32-4	105284101	1	シタイトテンビンダイササエ	L/TR. TAKE-UP LEVER BRACKET	
32-5	105285000	1	シタイトテンビンフタジク	L/TR. TAKE-UP LEVER COV. SHAFT	
32-6	540326051	1	シタイトテンビンダイ	L/TR. TAKE-UP LEVER BRACKET	
32-7	062670612	2	ナベコ357-40X6	SCREW, PAN SM3.57-40X6	
32-8	105287001	1	テンビンダイアンナイイタ	GUIDE PLATE	
32-9	105288001	2	シメネジ2.38	SCREW, SM2.38	
32-10	540327051	1	テンビンイトウケ	LOWER THREAD GUIDE	
32-11	060660416	1	バインド318-40X4	SCREW, BIND SM3.18-40X4	
32-12	540795101	2	DLテンビンイトアンナイ	LOWER THREAD GUIDE	
32-13	060660416	2	バインド318-40X4	SCREW, BIND SM3.18-40X4	
32-14	540328051	1	イトオサエドダイ	THREAD RELEASE BASE	
32-15	062660412	2	ナベコ318-40X4	SCREW, PAN SM3.18-40X4	
32-16	540329051	1	テンビンイトオサエ	LOWER THREAD PRESSER	
32-17	062660412	1	ナベコ318-40X4	SCREW, PAN SM3.18-40X4	
32-18	105296001	1	テンビンダイイトカケ	THREAD GUIDE	
32-19	111112001	1	シタイトイトアンナイイタ	LOWER THREAD GUIDE PLATE	
32-20	105288001	1	シメネジ2.38	SCREW, SM2.38	
32-21	026030136	1	ヒラザガネコガタ3	WASHER, PLAIN S 3	
33	047501242	1	スプリングピンAW5	PIN, SPRING ROLL AW5	
34	100064005	2	シメネジ3.57	SCREW, SM3.57	
35	540342051	1	シタイトテンビンネジツキH	LOWER THREAD TAKE-UP W/S, H	
35-1	014680422	2	アナトメネジ4.37クボミ	SET SCREW, SOCKET (CP) SM4.37	
36	105300101	1	シタイトオクリダシアンナイ	LOWER THREAD FEED BAR GUIDE	
37	147291001	1	ルーハイトアンナイダイ	LOOPER THREAD GUIDE BRACKET	
38	013760610	1	トメネジ5.95クボミ	SET SCREW, (CP) SM5.95	
39	111113101	1	イトキリアンナイイタ	THREAD TRIMMER GUIDE PLATE	
40	111114101	1	イトキリ	THREAD TRIMMER	
41	062670612	2	ナベコ357-40X6	SCREW, PAN SM3.57-40X6	
42	540335051	1	ルーバガワフタRA	LOOPER COVER, RA	
43	540338051	1	ルーバガワフタLA	LOOPER COVER, LA	

118-928-413



M2. 下糸通シ関係 (B928) / Lower threading mechanism (B928) / Untererfadens (B928)  
 / Mécanisme de l'enfilage inférieur (B928) / Mecanismo de le enhebrado inferior (B928)r

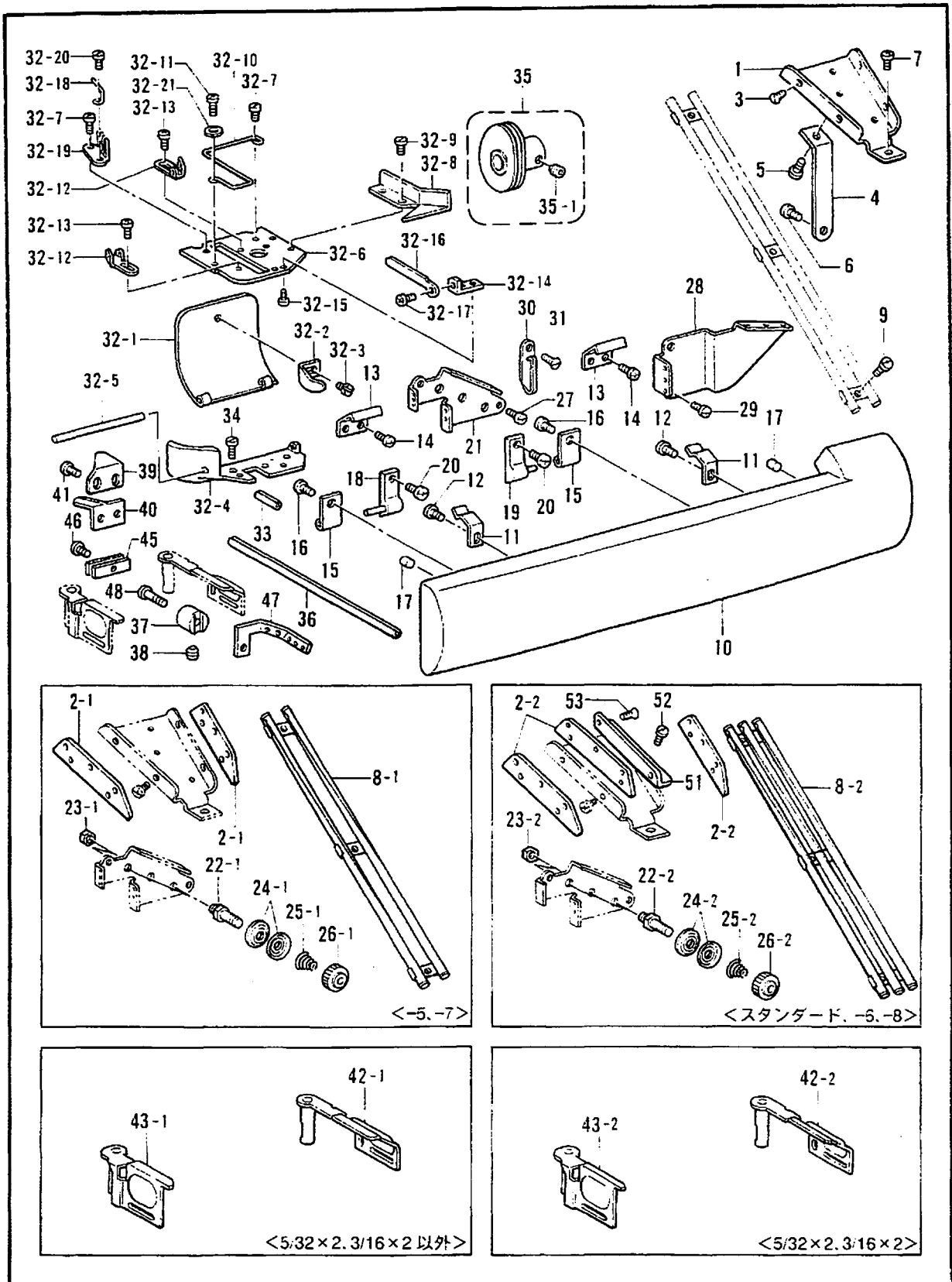

118-928-413

M2 . 下糸通シ関係 (B928) / Lower threading mechanism (B928) / Untererfadens (B928)  
 / Mécanisme de l'enfilage inférieur (B928) / Mecanismo de le enhebrado inferior (B928)r

REF.NO.	CODE	QTY	ヒンメイ	NAME OF PARTS	RM
45 48	S40799051 062671412	2 1	ルーバガワフタトメバネ ナベコ357-40X14	SPRING SCREW, PAN SM3.57-40X14	
8-1 22-1 23-1 24-1 25-1 26-1	105251009 S08987001 021680202 144504001 S40324001 155510001	1 2 2 4 2 2	<-5,-7用> シタイトタテアンナイクミ イトチヨウシボウ ナツト2シユ4.37 イトアンナイサラ イトアンナイバネ イトチヨウシナツト	<FOR "-5,-6"> INGLINED GUIDE TUBE ASSY THREAD TENSION CONTROL STUD NUT, 2 SM4.37 THREAD GUIDE DISC THREAD GUIDE SPRING TENSION NUT	
8-2 22-2 23-2 24-2 25-2 26-2 51 52 53	111097009 S08987001 021680202 144504001 S40324001 155510001 111072009 062630412 111073001	1 3 3 6 3 3 1 2 2	<スタンダード,-6,-8用> シタイトタテアンナイクミ イトチヨウシボウ ナツト2シユ4.37 イトアンナイサラ イトアンナイバネ イトチヨウシナツト ミツメイトアンナイトリツケイタ ナベコ238-56X4 サラネジ2.38	<FOR STANDARD,-6 & -8> INGLINED GUIDE TUBE ASSY THREAD TENSION CONTROL STUD NUT, 2 SM4.37 THREAD GUIDE DISC THREAD GUIDE SPRING TENSION NUT THREAD GUIDE SET PLATE SCREW, PAN SM2.38-56X4 SCREW, FLAT SM2.38	
42-1 43-1	S40336051 S40339051	1 1	<5/32X2, 3/16X2以外用> ルーバガワフタRB ルーバガワフタLB	<FOR WITHOUT "5/32X2, 3/16X2"> LOOPER COVER, RB LOOPER COVER, LB	
42-2 43-2	S40337051 S40340051	1 1	<5/32X2, 3/16X2用> ルーバガワフタRC ルーバガワフタLC	<FOR "5/32X2, 3/16X2"> LOOPER COVER, RC LOOPER COVER, LC	

118-928-413

Z1: 付属品関係 / Accessories / Zubehör / Accessoires / Accesorios

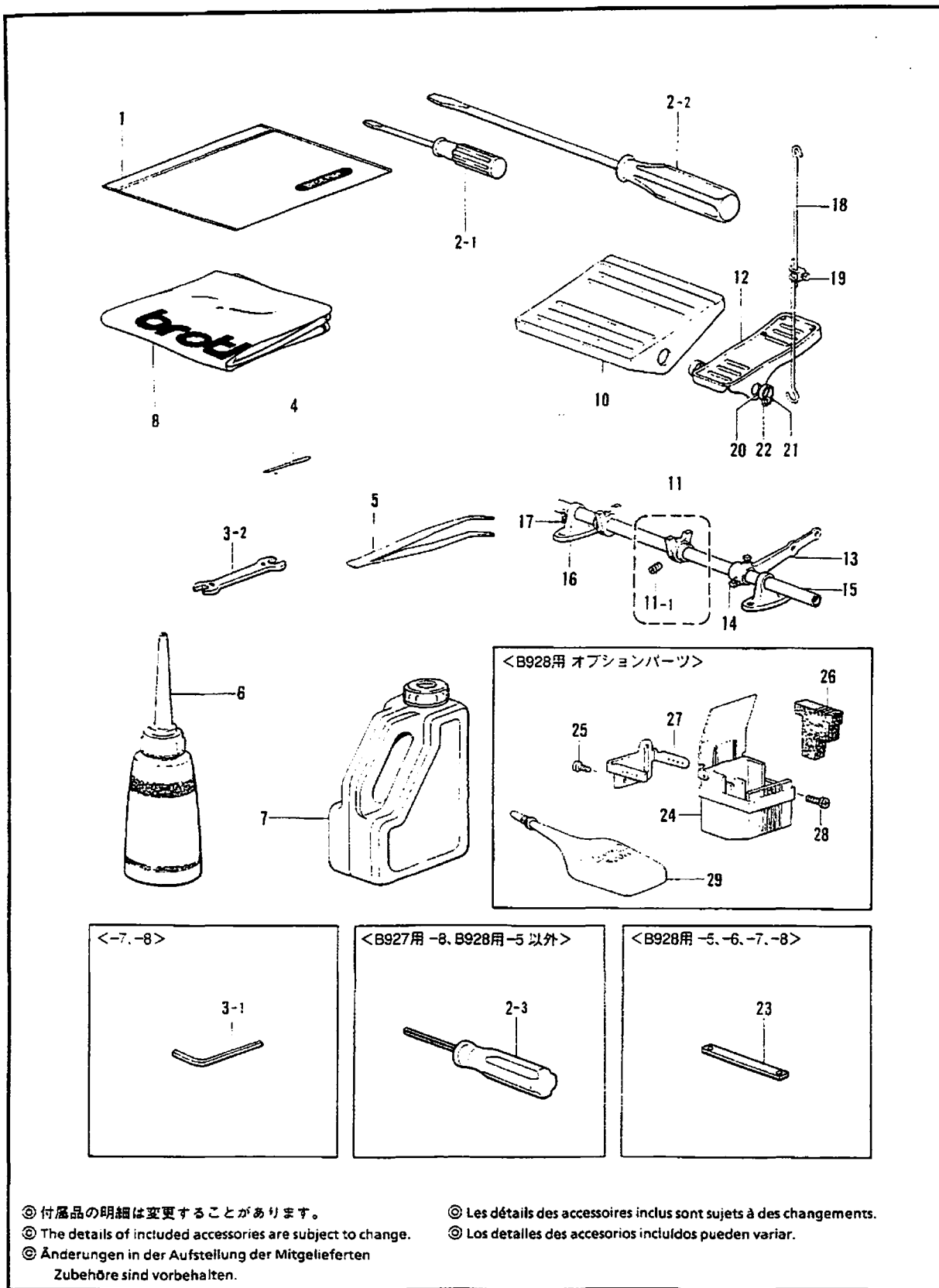

118-927-910

Z1 . 付属品関係 / Accessories / Zubehör / Accessoires / Accesorios

REF.NO.	CODE	Q'TY	ヒンメイ	NAME OF PARTS	RM
1	122991001	1	フゾクヒンポリフクロ	ACCESSORY BAG	
2-1	105344001	1	ネジマワシ2.6X70	SCREW DRIVER, 2.6X70	
2-2	101572101	1	ネジマワシ5.5X190	SCREW DRIVER, 5.5X190	
3-2	100887001	1	スパナ8X9	WRENCH, 8X9	
5	117466000	1	ピンセット	PINCETTE	
6	114483002	1	ポリオイラーケミ	OILER ASSY	
8	144228001	1	トウブカバー	HEAD COVER	
10	133636009	1	フミイタ	THREADLE PEDAL	
11	180827009	2	フミイタトメケミ	THREADLE PEDAL STOPPER ASSY	
11-1	151604001	4	トメネジ5.95	SET SCREW, SM5.95	
12	117437109	1	オサエアゲフミイタ	FOOT LIFTER PEDAL	
13	109656009	1	レンカンレバーL	CONNECTING LEVER, L	
14	100463001	2	カクボルト7.94	BOLT, SM7.94	
15	106062009	1	フミイタササエジク	THREADLE PEDAL SHAFT	
16	109657009	2	フミイタジクウケ	THREADLE PEDAL BRACKET	
17	081512502	4	+サラモク51X25	WOOD SCREW, FLAT M5.1X25	
18	105359001	2	レンカン	CONNECTING ROD	
19	181225001	1	レンカンダキケミ	CONNECTING ROD CLAMP ASSY	
20	116016001	2	ヘタルトメ	PEDAL STOPPER	
21	021400106	2	ナツト1シユ4	NUT, 1 M4	
22	062401406	2	ナベコ4X14	SCREW, PAN M4X14	
2-3	501943001	1	<B927用-8,B928用-5以外> 6カクボウネジマワシ1.6	<FOR B927 "-8", WITHOUT B928 "-5"> SCREW DRIVER, 1.6	
3-1	142721001	1	<-7,-8用> 6カクボウスパナ3	<FOR "-7,-8"> HEXAGONAL WRENCH, 3	
4	※	8	<B927用> ミシンハリTVX64NY	<FOR B927> NEEDLE, TVX64NY	
4	※	8	<B928用> ミシンハリTVX5	<FOR B928> NEEDLE, TVX5	
23	148298001	1	<B928用-5,-6,-7,-8> スパーサ	<FOR B928 "-5,-6,-7 & -8"> SPACER	
24	508758009	1	" オプション部品 "	" OPTIN PARTS "	
25	575456001	2	<B928用> ハライトレイキヤクタンクケミ +ナベPタイト3X10	<FOR B928> NEEDLE THREAD COOLER TANK ASSY TAPTITE, PAN P M3X10	
26	508761100	1	ハライトレイキヤクフェルト	FELT	
27	508969101	1	チユカナイトアンナイ	THREAD GUIDE	
28	060680712	2	バインド437-40X7	SCREW, BIND SM4.37X7	
29	506704001	1	シリコンオイル	SILICONE OIL	

118-927-910

Z2 . 付属品関係 / Accessories / Zubehör / Accessoires / Accesorios

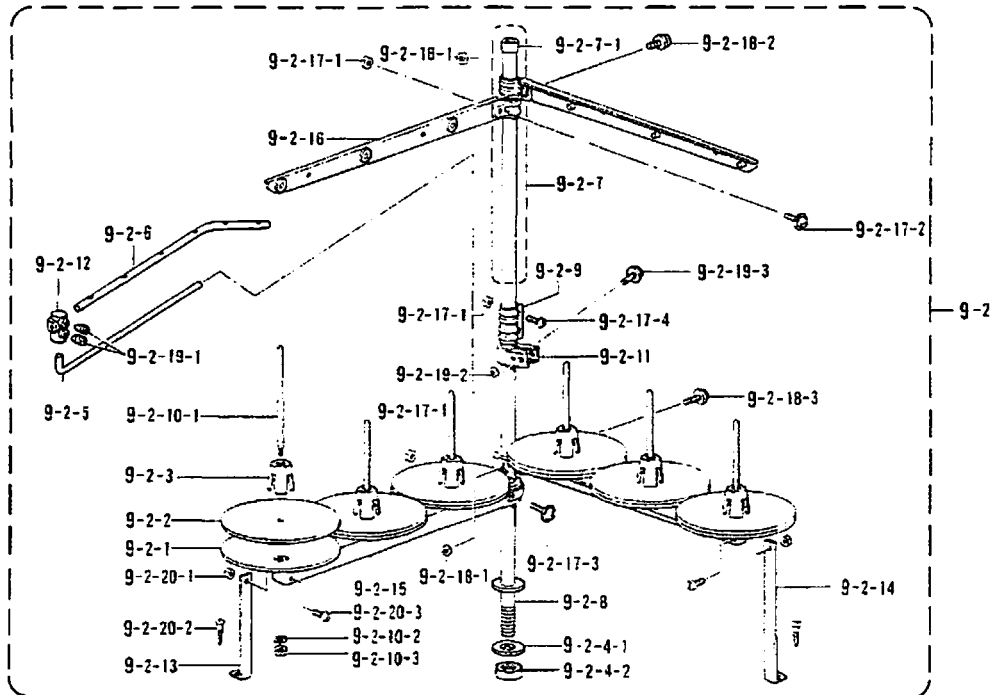
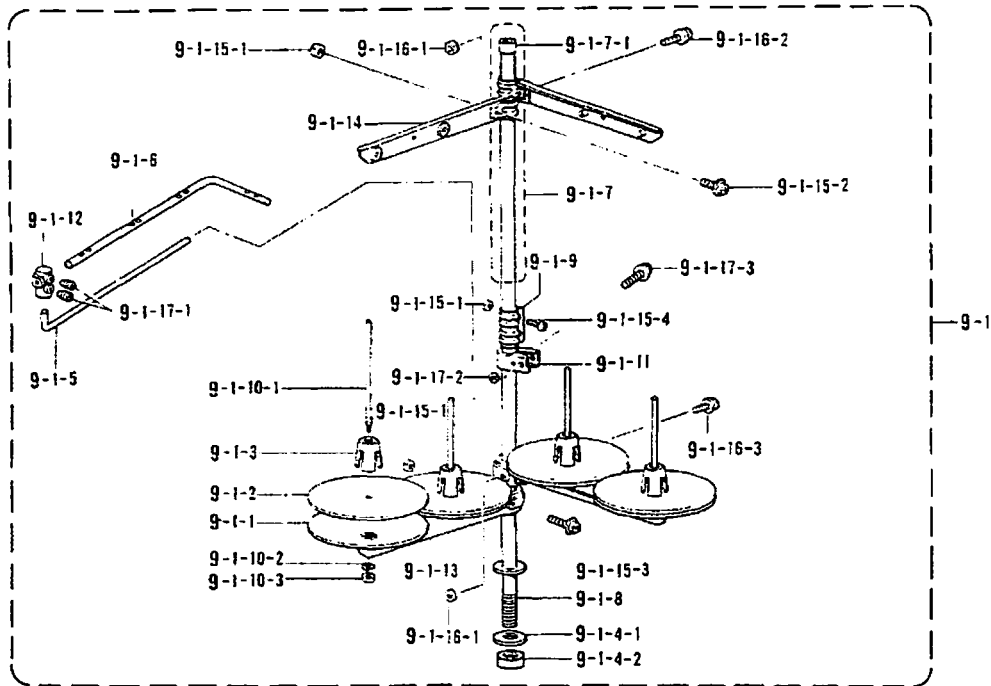

◎ 付属品の明細は変更することがあります。 ◎ Les détails des accessoires inclus sont sujets à des changements.  
 ◎ The details of included accessories are subject to change. ◎ Los detalles de accesorios incluidos pueden variar.  
 ◎ Änderungen in der Aufstellung der Mitgelieferten Zubehöre sind vorbehalten.

118-927-910

Z2 . 付属品関係 / Accessories / Zubehör / Accessoires / Accesorios

REF.NO.	CODE	Q'TY	ヒンメイ	NAME OF PARTS	RM
			<二本針用>	<FOR TWIN NEEDLE>	
9-1	S29854109	1	イトタテダイクミ4DTHF	COTTON STAND ASSY, 4DTHF	
9-1-1	150180001	4	ウケザラ	SPOOL STAND BASE	
9-1-2	150182000	4	スプールマット	SPOOL MAT	
9-1-3	126863001	4	スプールクッション	SPOOL CUSHION	
9-1-4	S02775001	1	パイフネジセットA	PIPE SCREW SET, A	
9-1-4-1	150206002	1	ヒラザガネ16	WASHER, PLAIN 16	
9-1-4-2	S38648001	1	6カクナツトU5/8	NUT, U5/8-28	
9-1-5	S04109001	1	イトアンナイササエボウ	THREAD GUIDE SUPPORT BAR	
9-1-6	142998101	1	イトアンナイ4	THREAD GUIDE, 4	
9-1-7	S40640001	1	コラムパイフキャツプツキ	COLUMN PIPE WITH CAP	
9-1-7-1	150174000	1	コラムキャツプ	COLUMN CAP	
9-1-8	156112003	1	コラムパイフD	COLUMN PIPE, D	
9-1-9	150173003	1	コラムジョイント	COLUMN JOINT	
9-1-10	S21798001	4	スプールネジセット	SPOOL SCREW SET	
9-1-10-1	150179002	4	スプールジクB	SPOOL SHAFT, B	
9-1-10-2	028050246	4	バネザガネ2-5	WASHER, SPRING 2-5	
9-1-10-3	021500106	4	1シユナツト5	NUT, 1 M5	
9-1-11	150185009	1	イトアンナイホルダー	THREAD GUIDE HOLDER	
9-1-12	138843001	1	ササエボウツギテ	JOINT	
9-1-13	S02778002	2	スプールホルダー2	SPOOL HOLDER, 2	
9-1-14	S02786002	2	スレツドハンガークミ2	THREAD HANGER ASSY, 2	
9-1-15	S40641001	1	スプールジクネジセットA	SPOOL SCREW SET, A	
9-1-15-1	021500106	4	1シユナツト5	NUT, 1 M5	
9-1-15-2	S37038001	1	ナベコヒラザ5X14	SCREW, PAN (P WASHER) M5X14	
9-1-15-3	S37037001	1	ナベコヒラザ5X32	SCREW, PAN (P WASHER) M5X32	
9-1-15-4	062501406	2	ナベコ5X14	SCREW, PAN M5X14	
9-1-16	S40642001	1	スプールジクネジセットB	SPOOL SHAFT SCREW SET, B	
9-1-16-1	021500106	2	1シユナツト5	NUT, 1 M5	
9-1-16-2	S37038001	1	ナベコヒラザ5X14	SCREW, PAN (P WASHER) M5X14	
9-1-16-3	S37037001	1	ナベコヒラザ5X32	SCREW, PAN (P WASHER) M5X32	
9-1-17	S40643001	1	ホルダーツギテネジセット	HOLDER JOINT SCREW SET	
9-1-17-1	014060632	2	アナトメ6X6クボミ	SET SCREW, SOCKET (CP) M6X6	
9-1-17-2	021500106	1	1シユナツト5	NUT, 1 M5	
9-1-17-3	S37037001	1	ナベコヒラザ5X32	SCREW, PAN (P WASHER) M5X32	

118-927-910

ZZ . 付属品関係 / Accessories / Zubehör / Accessoires / Accesorios

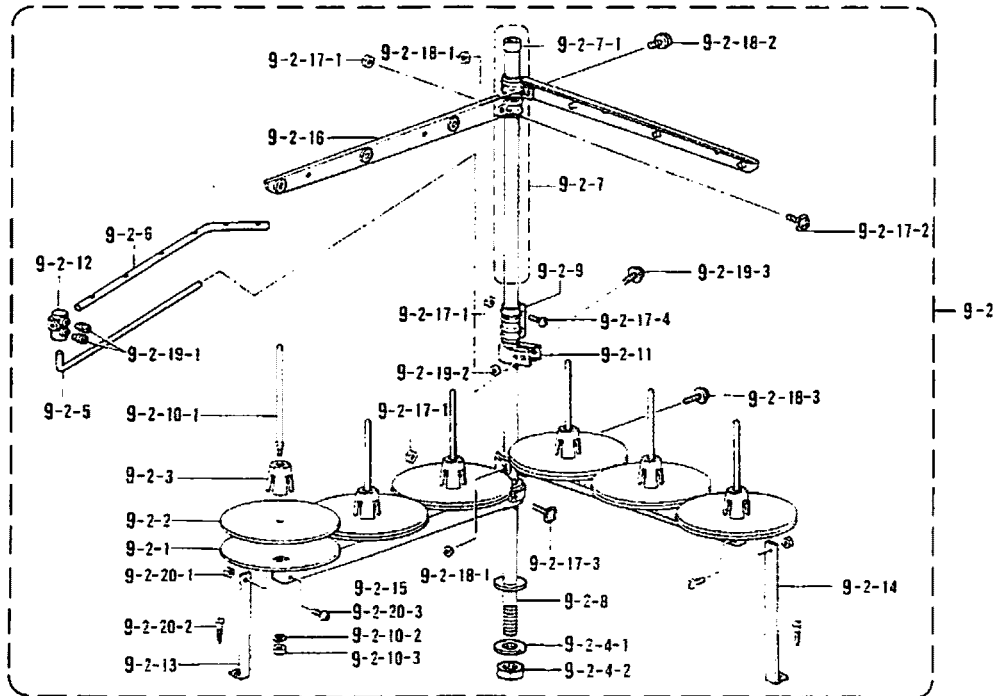
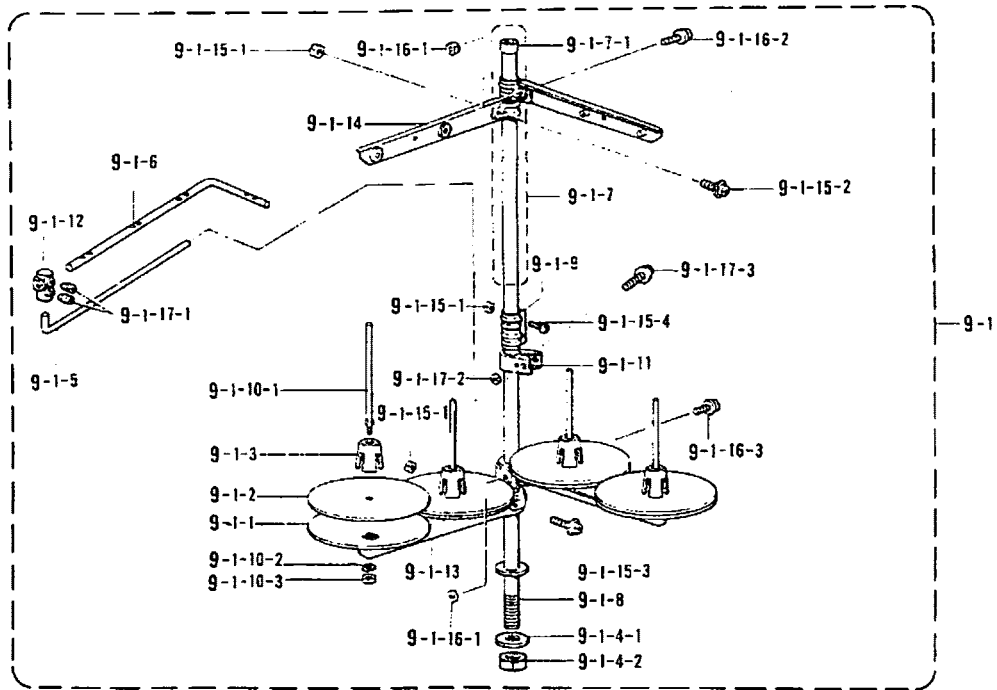

◎ 付属品の明細は変更することがあります。

◎ The details of included accessories are subject to change.

◎ Änderungen in der Aufstellung der Mitgelieferten  
Zubehöre sind vorbehalten.

◎ Les détails des accessoires inclus sont sujets à des changements.

◎ Los detalles de accesorios incluidos pueden variar.

118-927-910















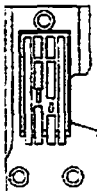
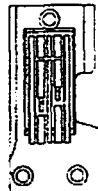
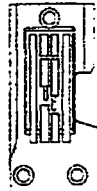

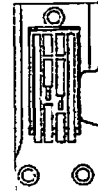
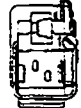
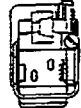

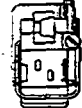

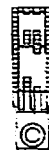

Z2 . 付属品関係 / Accessories / Zubehör / Accessoires / Accesorios

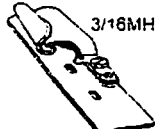
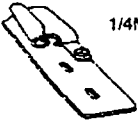
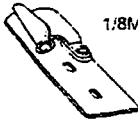
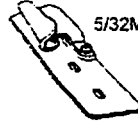
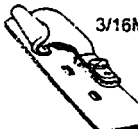
REF.NO.	CODE	Q'TY	ヒンメイ	NAME OF PARTS	RM
9-2	S29864109	1	<三本針用> イトタテダイクミ6DTHF	<FOR THREE NEEDLE> COTTON STAND ASSY, 6DTHF	
9-2-1	150180001	6	ウケザラ	SPOOL STAND BASE	
9-2-2	150182000	6	スプールマット	SPOOL MAT	
9-2-3	126863001	6	スプールクッション	SPOOL CUSHION	
9-2-4	S02775001	1	パイプネジセットA	PIPE SCREW SET, A	
9-2-4-1	150206002	1	ヒラザガネ16	WASHER, PLAIN 16	
9-2-4-2	S38648001	1	6カクナツトU5/8	NUT, U5/8-28	
9-2-5	S04109001	1	イトアンナイササエボウ	THREAD GUIDE SUPPORT BAR	
9-2-6	S02783001	1	イトアンナイ6	THREAD GUIDE, 6	
9-2-7	S40640001	1	コラムパイプキャップツキ	COLUMN PIPE WITH CAP	
9-2-7-1	150174000	1	コラムキャップ	COLUMN CAP	
9-2-8	156112003	1	コラムパイプD	COLUMN PIPE, D	
9-2-9	150173003	1	コラムジョイント	COLUMN JOINT	
9-2-10	S21798001	6	スプールネジセット	SPOOL SCREW SET	
9-2-10-1	150179002	6	スプールジクB	SPOOL SHAFT, B	
9-2-10-2	028050246	6	バネザガネ2-5	WASHER, SPRING 2-5	
9-2-10-3	021500106	6	1シユナツト5	NUT, 1 M5	
9-2-11	150185009	1	イトアンナイホルダー	THREAD GUIDE HOLDER	
9-2-12	138843001	1	ササエボウツギテ	JOINT	
9-2-13	150188009	1	スプールホルダーササエA	SPOOL HOLDER SUPPORT, A	
9-2-14	150194009	1	スプールホルダーササエB	SPOOL HOLDER SUPPORT, B	
9-2-15	S02779009	2	スプールホルダー3	SPOOL HOLDER, 3	
9-2-16	S02788009	2	スレツドハンガークミ3	THREAD HANGER ASSY, 3	
9-2-17	S40641001	1	スプールジクネジセットA	SPOOL SCREW SET, A	
9-2-17-1	021500106	4	1シユナツト5	NUT, 1 M5	
9-2-17-2	S37038001	1	ナベコヒラザ5X14	SCREW, PAN (P WASHER) M5X14	
9-2-17-3	S37037001	1	ナベコヒラザ5X32	SCREW, PAN (P WASHER) M5X32	
9-2-17-4	062501406	2	ナベコ5X14	SCREW, PAN M5X14	
9-2-18	S40642001	1	スプールジクネジセットB	SPOOL SHAFT SCREW SET, B	
9-2-18-1	021500106	2	1シユナツト5	NUT, 1 M5	
9-2-18-2	S37038001	1	ナベコヒラザ5X14	SCREW, PAN (P WASHER) M5X14	
9-2-18-3	S37037001	1	ナベコヒラザ5X32	SCREW, PAN (P WASHER) M5X32	
9-2-19	S40643001	1	ホルダーツギテネジセット	HOLDER JOINT SCREW SET	
9-2-19-1	014060632	2	アナトメ6X6クボミ	SET SCREW, SOCKET (CP) M6X6	
9-2-19-2	021500106	1	1シユナツト5	NUT, 1 M5	
9-2-19-3	S37037001	1	ナベコヒラザ5X32	SCREW, PAN (P WASHER) M5X32	
9-2-20	S40644001	2	ホルダーツギテネジセット	HOLDER JOINT SCREW SET	
9-2-20-1	021500106	2	1シユナツト5	NUT, 1 M5	
9-2-20-2	031452206	2	マルモク45X22	WOOD SCREW, ROUND M4.5X22	
9-2-20-3	062501006	2	ナベコ5X10	SCREW, PAN M5X10	

118-927-910















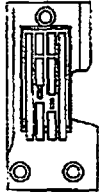
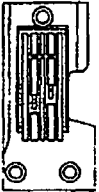

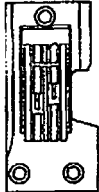



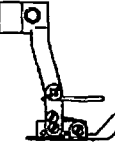
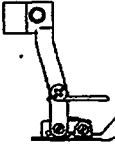
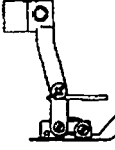









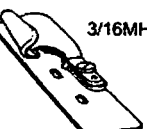
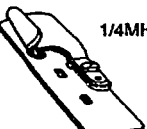
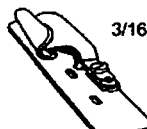
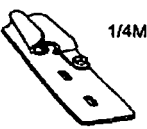

B927 仕様別部品一覧表 / DIFFERENT PARTS LIST / ZUBEHÖRLISTE /  
 LISTE DES PIÈCES ACCESSOIRES / LISTA DE PIEZAS ACCESORIAS

参照番号 Ref.No.	品名 Name of part	薄物用 / Thin materials		中厚物用 / Medium materials		
		4.8mm [3/16]	6.4mm [1/4]	3.2mm [1/8]	4.0mm [5/32]	4.8mm [3/16]
G-1	ハリダキネジツキ Needle clamp with screw	 183954-001	 183978-001	 183953-001	 183951-001	 183954-001
G-2	ハリ / Needle 針数 (本) No. of needles	TVX64NY#12 (2) S36861-012	←	TVX64NY#14 (2) S36861-014	←	←
G-3	ハライト Needle plate	 S05946-101	 S11508-101	 S40371-001	 S40373-001	 S05946-101
G-5	オサエクミ Presser foot assy	 S40355-001	 S40363-001	 S40367-001	 S40365-001	 S40355-001
G-7	オクリバ Feed dog	 S40369-001	 S40370-001	 S40372-001	←	 S40369-001
G-10	ハリウケ Needle guard	 S06310-001	 148973-001	 S06310-001	←	←
G-13	ラッパークミ Lapper assy	 101494-001	 S09679-001	 101488-001	 101949-001	 101497-001
G-20-1	ルーバーS Looper (S)	 S40391-001	 S40393-001	 S40389-001	←	 S40391-001
G-20-2	ルーバーL Looper (L)	 S40392-001	 S40394-001	 S40390-001	←	 S40392-001

























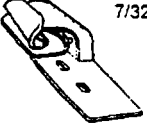
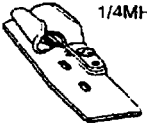
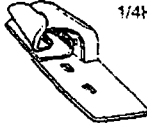
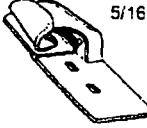
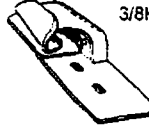
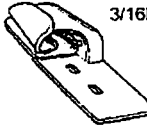

118-927-231

B927 仕様別部品一覧表 / DIFFERENT PARTS LIST / ZUBEHÖRLISTE /  
LISTE DES PIÈCES ACCESSOIRES / LISTA DE PIEZAS ACCESORIAS

中厚物用 / Medium materials			- 7 薄物用 / Thin materials			参照番号 Ref.No.
4.8mm [3/16] 固定針受け / Fixed N. Guard	6.4mm [1/4]	6.4mm [1/4] 固定針受け / Fixed N. Guard	4.8mm [3/16]	6.4mm [1/4]	3.2mmx2 [1/8x2]	
 183954-001	 183978-001	←	 183954-001	 183978-001	 S16500-001	G-1 ハリダキ ネジツキ Needle clamp with screw
TVX64NY#14 (2) S36861-014	TVX64NY#16 (2) S36861-016	←	TVX64NY#11PSU (2) S36861-031	←	TVX64NY#11PSU (3) S36861-031	G-2 ハリ / Needle 針数 (本) No. of needles
 S05946-101	 S11508-101	←	 S06318-101	 S09672-101	 S16475-101	G-3 ハリイタ Needle plate
 101491-101	 106160-101	←	 S06303-101	 S09673-101	 S16477-101	G-5 オサエクミ Presser foot assy
 S05947-001	 S40370-001	 S11509-001	 S06319-101	 S09678-001	 S16476-001	G-7 オクリバ Feed dog
 105302-001	 148973-001	 106170-001	 S06310-001	 148973-001	 S16482-001	G-10 ハリウケ Needle guard
 101497-001	 101561-001	←	 101494-001	 S09679-001	←	G-13 ラッパー Lapper assy
 S40391-001	 S40393-001	←	 S40391-001	 S40393-001	(S) S40375-001	G-20-1 ルーバー-S Looper (S)
 S40392-001	 S40394-001	←	 S40392-001	 S40394-001	(M) S40376-001	G-20-2 ルーバー-L Looper (L)
					(L) S40377-001	













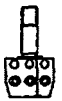



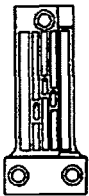
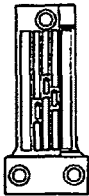
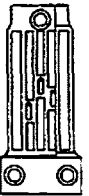
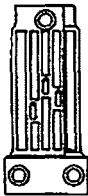
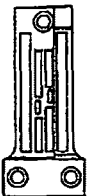
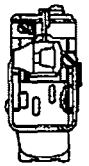



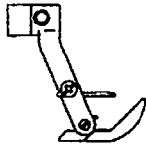

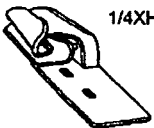
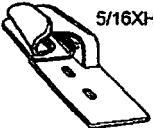
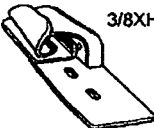
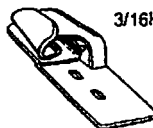

118-927-231

B928 仕様別部品一覧表 / DIFFERENT PARTS LIST / ZUBEHÖRLISTE /  
LISTE DES PIÈCES ACCESSOIRES / LISTA DE PIEZAS ACCESORIAS

参照番号 Ref.No.	厚物用 / Heavy materials					- 5 厚物 / Heavy materials
	2.8mmx2 [7/64x2]	3.2mmx2 [1/8x2]	3.2mmx2 [1/8x2]	4.0mmx2 [5/32x2]	4.8mmx2 [3/16x2]	4.8mm [3/16]
G-1 ハリダキ ネジツキ Needle clamp with screw	 183952-001	 181716-001	←	 181723-001	 181722-001	 183954-001
G-2 針・針数 (本) Needle No. of needles	TVX5#130 (3) S43401-021	←	←	←	←	TVX5#130 (2) S43401-021
G-3 ハリイタ Needle plate	 S40790-001	 S13042-001	←	 S40787-001	 S40783-001	 159583-001
G-5 オサエクミ Presser foot assy	 S40788-001	 S40386-001	←	 S40785-001	 S40781-001	 159584-201
G-7 オクリバ Feed dog	 S13045-101	←	←	 S40784-001	←	 159588-001
G-14 ラッパー クミ Lapper assy	 111171-001	 101561-001	 101564-001	 111177-001	 111183-001	 159609-001
G-18-1 ルーバーS Looper (S)	 S40375-001	←	←	 S40395-001	←	 S40375-001
G-18-2 ルーバーM Looper (M)	 S40376-001	←	←	←	←	—
G-18-3 ルーバーL Looper (L)	 S40377-001	←	←	 S40396-001	←	 S40377-001

















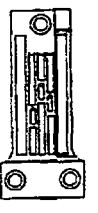
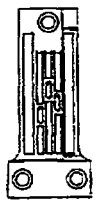
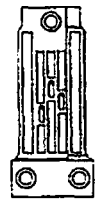

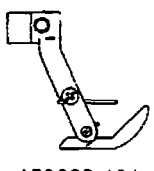
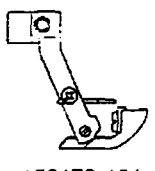
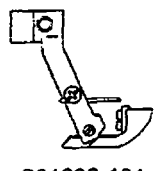
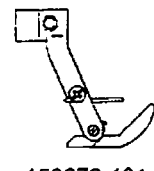
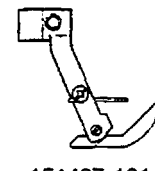
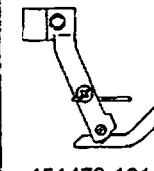

119-928-221

B928 仕様別部品一覧表 / DIFFERENT PARTS LIST / ZUBEHÖRLISTE /  
LISTE DES PIÉCES ACCESSOIRES / LISTA DE PIEZAS ACCESORIAS

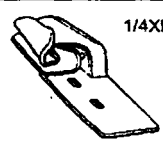
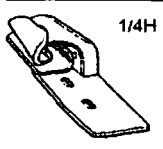
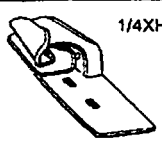
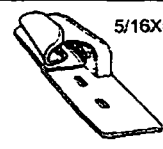
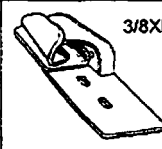
- 5		- 6			- 7	参照番号 Ref.No.
デニム用 / Extra heavy materials						
6.4mm [1/4]	3.2mmx2 [1/8x2] 段差 1.0 / Height Difference 1.0	3.2mmx2 [1/8x2] 段差 1.9 / Height Difference 1.9	4.0mmx2 [5/32x2]	4.8mmx2 [3/16x2]	4.8mm [3/16]	
 183978-001	 181716-001	←	 181723-001	 181722-001	 183954-001	G-1 ハリダキ ネジツキ Needle clamp with screw
TVX5#140 (2) S43401-022	TVX5#140 (3) S43401-022	←	←	←	TVX5#130 (2) S43401-021	G-2 針・針数 (本) Needle No. of needles
 147867-001	 S18086-001	 148864-001	 148944-001	 148927-001	 159614-001	G-3 ハリイタ Needle plate
 147868-201	 S18081-201	 148865-201	 148945-201	 148928-201	 159615-101	G-5 オサエクミ Presser foot assy
 148971-001	 S18084-101	 148867-101	 148932-101	←	 159616-001	G-7 オクリバ Feed dog
 147302-001	←	←	 148951-001	 148936-001	 159609-001	G-14 ラッパー クミ Lapper assy
 S40375-001	←	←	 S40395-001	←	 S40375-001	G-18-1 ルーバーS Looper (S)
／	 S40376-001	←	←	←	／	G-18-2 ルーバーM Looper (M)
 S40377-001	←	←	 S40396-001	←	 S40377-001	G-18-3 ルーバーL Looper (L)

118-928-231



B928 仕様別部品一覧表 / DIFFERENT PARTS LIST / ZUBEHÖRLISTE /  
LISTE DES PIÈCES ACCESSOIRES / LISTA DE PIEZAS ACCESORIAS

参照番号 Ref.No.	- 7		- 8			
	デニム / Extra heavy	厚物 / Heavy materials	デニム用 / Extra heavy materials			
	6.4mm [1/4]	3.2mmx2 [1/8x2] 段差 1.0 / Height Difference 0	3.2mmx2 [1/8x2] 段差 1.0 / Height Difference 1.0	3.2mmx2 [1/8x2] 段差 1.9 / Height Difference 1.9	4.0mmx2 [5/32x2]	4.8mmx2 [3/16x2]
G-1 ハリダキ ネジツキ Needle clamp with screw	 183978-001	 181716-001	←	←	 181723-001	 181722-001
G-2 針・針数 (本) Needle No. of needles	TVX5#140 (2) S43401-022	TVX5#130 (3) S43401-021	TVX5#140 (3) S43401-022	←	←	←
G-3 ハリイタ Needle plate	 150666-001	 156175-001	 S01634-001	 150667-001	 151486-001	 151478-001
G-5 オサエクミ Presser foot assy	 150668-101	 156179-101	 S01632-101	 150672-101	 151487-101	 151479-101
G-7 オクリバ Feed dog	 150673-001	 156182-101	 S01635-101	 150675-101	 151483-101	←
G-14 ラッパー クミ Lapper assy	 147302-001	 101564-001	 147302-001	←	 148951-001	 148936-001
G-18-1 ルーバー-S Looper (S)	 S40375-001	←	←	←	 S40395-001	←
G-18-2 ルーバー-M Looper (M)	—	 S40376-001	←	←	←	←
G-18-3 ルーバー-L Looper (L)	 S40377-001	←	←	←	 S40396-001	←

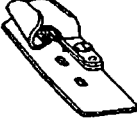

113-928-201

**B928 オプション部品 / OPTION PARTS LIST / SONDERZUBEHÖR /  
PIECES EN OPTION / PIEZAS OPCONALES**

G-5  オサエクミ Presser foot assy	厚物用 / Heavy materials 3.2mmx2 [1/8x2]
	  S13043-101

G-14  ラッパークミ Lapper assy	中厚物用 / Medium materials		
	7/32MH    111168-001	5/16MH    111174-001	3/8MH    111180-001

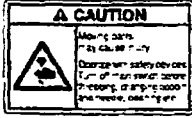
警告ラベル／Warning labels／Warnschilder／  
Etiquettes d'avertissement／Etiquetas de advertencia

	品名／Name of parts	Size(mm)	Code
	操作注意ラベル・和	40×64	S38350-001
	Label, operation Eng.	40×64	S38349-001
	アースマーク Mark, grounding	φ12	S37060-001



索引 / INDEX / VERZEICHIS  
/ INDEX / INDICE

CODE	REF.NO.	Page
SS4037700	G-20-2	56
SS4340102	G-2	58
S01295001	G3 - 5-1-3	16
	G4 - 5-3	18
	G5 - 5-3	20
S01632101	G-5	59
S01634001	G-3	59
S01635101	G7 - 7-2	24
	G-7	59
S01637001	G5 - 7-2-1	20
	G7 - 7-2-1	24
S01943001	Z1 - 2-3	50
S02775001	Z2 - 9-1-4	52
	Z2 - 9-2-4	54
S02778002	Z2 - 9-1-13	52
S02779009	Z2 - 9-2-15	54
S02783001	Z2 - 9-2-6	54
S02786002	Z2 - 9-1-14	52
S02788009	Z2 - 9-2-16	54
S04109001	Z2 - 9-1-5	52
	Z2 - 9-2-5	54
S05946101	G-3	55
	G-3	55
	G-3	56
S05947001	G-7	56
S06259001	D1 - 1-1	4
	D2 - 1-1	6
S06260001	D2 - 1-3	6
S06261001	D1 - 1-2	4
	D2 - 1-2	6
S06303101	G2 - 5-1	14
	G-5	56
S06309001	G2 - 5-1-2	14
	G2 - 5-2-2	14
S06310001	G-10	55
	G-10	55
	G-10	56
S06311201	H - 5-22-1	28
S06314001	G1 - 22-2	12
	G2 - 22-2	14
S06315001	G1 - 22-1	12
	G2 - 22-1	14
S06318101	G-3	56
S06319101	G-7	56
S06704001	Z1 - 29	50
S08758009	Z1 - 24	50
S08761100	Z1 - 26	50
S08969101	Z1 - 27	50
S08987001	M1 - 22-1	44
	M1 - 22-2	44
	M1 - 54	44
	M2 - 22-1	48
	M2 - 22-2	48
S09180101	G2 - 5-1-5	14
	G2 - 5-2-4	14
S09397001	G3 - 5-2-1	16
S09672101	G-3	56
S09673101	G-5	56
S09678001	G-7	56
S09679001	G1 - 13-3	12
	G2 - 13-2	14
	G-13	55
	G-13	56

CODE	REF.NO.	Page
S11508101	G-3	55
	G-3	56
S11509001	G-7	56
S13042001	G-3	57
S13043101	G-5	60
S13045101	G-7	57
S16475101	G-3	56
S16476001	G-7	56
S16477101	G-5	56
S16482001	G-10	56
S16487151	M1 - 47-2	44
S16488001	H - 10	28
S16490101	K - 16-2	32
S16500001	G-1	56
S18018201	G-5	58
S18084101	G5 - 7-2	20
	G-7	58
S18086001	G-3	58
S18874001	C - 7	4
S21798001	Z2 - 9-1-10	52
	Z2 - 9-2-10	54
S25125001	H - 1-7	26
S25126001	H - 1-20	26
S29854109	Z2 - 9-1	52
S29864109	Z2 - 9-2	54
S30564000	L1 - 7-1-1-8	34
	L1 - 7-2-1-8	34
	L2 - 7-1-1-8	38
	L2 - 7-2-1-8	40
S30565002	L1 - 7-1-1-9	34
	L1 - 7-2-1-9	34
	L2 - 7-1-1-9	38
	L2 - 7-2-1-9	40
S30565003	L1 - 7-1-1-10	34
	L1 - 7-2-1-10	36
	L2 - 7-1-1-10	38
	L2 - 7-2-1-10	40
S30565004	L1 - 7-2-1-11	36
	L2 - 7-2-1-11	40
S36058001	H - 1-15	26
S36061001	H - 1-24	26
S36861012	G-2	55
S36861014	G-2	55
	G-2	56
S36861016	G-2	56
S36861031	G-2	56
	G-2	56
S36862001	K - 29	32
S37037001	Z2 - 9-1-15-3	52
	Z2 - 9-1-16-3	52
	Z2 - 9-1-17-3	52
	Z2 - 9-2-17-3	54
	Z2 - 9-2-18-3	54
	Z2 - 9-2-19-3	54
S37038001	Z2 - 9-1-15-2	52
	Z2 - 9-1-16-2	52
	Z2 - 9-2-17-2	54
	Z2 - 9-2-18-2	54
S37060001		61
S37186001	L1 - 23	34
	L2 - 34	38
S38309001	F - 1-1-3	10
	F - 1-2-3	10

CODE	REF.NO.	Page
S38309001	F - 1-3-3	10
S38349001		61
S38350001		61
S38648001	Z2 - 9-1-4-2	52
	Z2 - 9-2-4-2	54
S39585001	F - 1-1-4	10
	F - 1-2-4	10
	F - 1-3-4	10
S39586001	F - 1-1-5	10
	F - 1-2-5	10
	F - 1-3-5	10
S40258001	E - 8	8
S40259001	E - 10	8
S40261001	E - 17	8
S40262001	E - 18	8
S40264001	E - 25	8
S40265001	E - 3-1	8
S40266051	M1 - 32	42
	M2 - 32	46
S40268001	C - 1	4
S40271051	C - 9-1	4
S40272051	C - 9-2	4
S40273051	C - 9-3	4
S40274001	F - 1-1	10
S40274002	F - 1-2	10
S40279001	D1 - 16	4
	D2 - 22	6
S40280001	E - 1-1	8
S40281001	E - 1-2	8
S40282000	F - 3	10
S40285001	F - 5	10
S40288000	F - 6	10
S40289051	F - 7	10
S40290051	F - 12	10
S40291001	F - 1-3	10
S40298051	D1 - 6	4
S40299001	D1 - 2	4
S40300001	D1 - 13	4
	D2 - 19	6
S40301001	D1 - 14	4
	D2 - 20	6
S40302000	K - 2	32
S40303001	K - 7	32
S40306001	K - 20	32
S40307001	K - 21	32
S40308001	K - 24	32
S40310001	L1 - 12	34
	L2 - 12	38
S40312001	L1 - 12-1	34
	L2 - 12-1	38
S40313051	L1 - 13	34
	L2 - 13	38
S40314001	B - 1	2
S40315051	B - 5	2
S40316051	B - 6	2
	J - 8	30
S40317001	B - 9	2
S40318051	B - 8	2
S40319001	M1 - 10	42
	M2 - 10	46
S40320051	M1 - 11	42
	M2 - 11	46
S40321051	M1 - 13	42



CODE	REF.NO.	Page
S40321051	M2 - 13	46
S40322051	M1 - 15	42
	M2 - 15	46
S40323001	M1 - 21	42
	M2 - 21	46
S40324001	M1 - 25-1	44
	M1 - 25-2	44
	M1 - 57	44
	M2 - 25-1	48
	M2 - 25-2	48
S40325001	M1 - 28	42
	M2 - 28	46
S40326051	M1 - 32-6	42
	M2 - 32-6	46
S40327051	M1 - 32-10	42
	M2 - 32-10	46
S40328051	M1 - 32-14	42
	M2 - 32-14	46
S40329051	M1 - 32-16	42
	M2 - 32-16	46
S40330051	M1 - 35	42
S40335051	M1 - 42	42
	M2 - 42	46
S40336051	M2 - 42-1	48
S40337051	M2 - 42-2	48
S40338051	M1 - 43	42
	M2 - 43	46
S40339051	M2 - 43-1	48
S40340051	M2 - 43-2	48
S40341001	M1 - 49	44
S40342051	M2 - 35	46
S40355001	G-5	55
	G-5	55
S40358001	G1 - 5-3-2	12
S40360001	G1 - 5-3-4	12
S40363001	G-5	55
S40365001	G-5	55
S40367001	G-5	55
S40369001	G-7	55
	G-7	55
S40370001	G-7	55
	G-7	56
S40371001	G-3	55
S40372001	G-7	55
S40373001	G-3	55
S40374001	G1 - 5-3-6	12
S40375001	G2 - 20-3	14
	G4 - 18-1	18
	G5 - 18-1	20
	G6 - 18-1	22
	G-18-1	57
	G-18-1	57
	G-18-1	58
	G-18-1	58
	G-18-1	59
	G-20-1	56
S40376001	G2 - 20-4	14
	G5 - 18-2	20
	G-18-2	57
	G-18-2	58
	G-18-2	59
	G-20-1	56
S40377001	G2 - 20-5	14

CODE	REF.NO.	Page
S40377001	G4 - 18-3	18
	G5 - 18-3	20
	G6 - 18-3	22
	G-18-3	57
	G-18-3	57
	G-18-3	58
	G-18-3	58
	G-18-3	59
S40378051	G2 - 22-3	14
	G3 - 20-1	16
	G4 - 20-1	18
	G5 - 20-1	20
	G6 - 20-1	22
	G7 - 20-1	24
S40379051	G2 - 22-4	14
	G3 - 20-2	16
	G5 - 20-2	20
	G7 - 20-2	24
S40380051	G2 - 22-5	14
	G3 - 20-3	16
	G4 - 20-3	18
	G5 - 20-3	20
	G6 - 20-3	22
	G7 - 20-3	24
S40383001	B - 10-1	2
S40386001	G-5	57
S40389001	G-20-1	55
S40390001	G-20-2	55
S40391001	G-20-1	55
	G-20-1	55
	G-20-1	56
	G-20-1	56
S40392001	G-20-2	55
	G-20-2	55
	G-20-2	56
	G-20-2	56
S40393001	G-20-1	55
	G-20-1	56
	G-20-1	56
S40394001	G-20-2	55
	G-20-2	56
	G-20-2	56
S40395001	G-18-1	57
	G-18-1	58
	G-18-1	59
S40396001	G-18-3	57
	G-18-3	58
	G-18-3	59
S40399001	G1 - 11	12
	G2 - 11	14
	G3 - 11	16
	G4 - 11	18
	G5 - 11	20
	G6 - 11	22
	G7 - 11	24
S40640001	Z2 - 9-1-7	52
	Z2 - 9-2-7	54
S40641001	Z2 - 9-1-15	52
	Z2 - 9-2-17	54
S40642001	Z2 - 9-1-16	52
	Z2 - 9-2-18	54
S40643001	Z2 - 9-1-17	52
	Z2 - 9-2-19	54

CODE	REF.NO.	Page
S40644001	Z2 - 9-2-20	54
S40781001	G-5	57
S40783001	G-3	57
S40784001	G-7	57
S40785001	G-5	57
S40787001	G-3	57
S40788001	G3 - 5-2	16
	G-5	57
S40790001	G-3	57
S40792001	K - 7-3	32
S40793051	K - 8	32
S40795101	M1 - 32-12	42
	M2 - 32-12	46
S40796001	E - 14	8
S40797000	E - 21	8
S40798050	D1 - 4	4
	D2 - 4	6
S40799051	M1 - 45	42
	M2 - 45	48
S40800001	F - 13	10
S40804001	G3 - 5-1-7	16
S40812001	B - 10	2
S40818001	E - 5	8
S40819000	E - 7	8
S41311051	F - 9	10
S41312001	E - 3-2	8
S41314000	H - 5-3	26
S41315001	H - 5-22-2	28
S41316009	L2 - 7-1	38
S41318009	L2 - 7-2	40
S43401021	G3 - 2	16
	G-2	57
	G-2	57
	G-2	58
	G-2	59
S43401022	G-2	58
	G-2	59
	G-2	59
S43446009	L1 - 7-1	34
S43448009	L1 - 7-2	34
080622502	A - 4	2
081512502	Z1 - 17	50
012060632	F - 2	10
013760610	L2 - 22	38
	M1 - 38	42
	M2 - 38	46
014060632	Z2 - 9-1-17-1	52
	Z2 - 9-2-19-1	54
014680422	H - 1-27	26
	H - 5-15	28
	H - 5-20	28
	H - 5-23	28
	M1 - 35-1	42
	M2 - 35-1	46
014680622	H - 5-23	28
014760622	E - 23	8
	F - 8	10
	H - 1-5	26
	H - 1-10	26
	H - 1-16	26
	H - 1-17	26
	H - 1-23	26
	H - 1-25	26

CODE	REF.NO.	Page
014760622	H -11	28
	H -11	28
	D1 -5	4
	D2 -5	6
	G2 -6	14
	G6 -6	22
	G7 -6	24
014761030	F -11	10
	K -14	32
014770622	E -4	8
	E -6	8
	F -4-1-1	10
	F -4-2-1	10
	H -5-12	28
014771022	C -10	4
014781032	E -2	8
017821813	H -3	26
017822212	H -2	26
021400106	Z1 -21	50
021500106	Z2 -9-1-10-3	52
	Z2 -9-1-15-1	52
	Z2 -9-1-16-1	52
	Z2 -9-1-17-2	52
	Z2 -9-2-10-3	54
	Z2 -9-2-17-1	54
	Z2 -9-2-18-1	54
	Z2 -9-2-19-2	54
	Z2 -9-2-20-1	54
021670102	G1 -18	12
	G2 -18	14
	G3 -16	16
	G4 -16	18
	G5 -16	20
	G6 -16	22
	G7 -16	24
021680202	M1 -23-1	44
	M1 -23-2	44
	M2 -23-1	48
	M2 -23-2	48
021710212	D2 -11	6
025060232	H -5-29	28
025080132	H -4	26
025710132	F -15	10
026030136	M1 -32-21	42
	M2 -32-21	46
028050246	Z2 -9-1-10-2	52
	Z2 -9-2-10-2	54
031452206	Z2 -9-2-20-2	54
047200842	M1 -44	42
047201640	H -1-1-1	26
047301242	F -1-1-1-1	10
	F -1-1-2-1	10
	F -1-2-1-1	10
	F -1-2-2-1	10
	F -1-3-1-1	10
	F -1-3-2-1	10
047501242	M1 -33	42
	M2 -33	46
048040342	F -16	10
	H -1-44	26
048420242	B -4	2
	J -7	30
060660416	M1 -32-11	42

CODE	REF.NO.	Page
060660416	M1 -32-13	42
	M2 -32-11	46
	M2 -32-13	46
060660512	G2 -5-1-6	14
	G2 -5-2-5	14
	G6 -5-5	22
	G7 -5-1-5	24
	G7 -5-2-5	24
	G7 -5-3-6	24
060670512	M1 -12	42
	M2 -12	46
060670612	L2 -19	38
060670812	G1 -6	12
	G3 -6	16
	G4 -6	18
	G5 -6	20
	L1 -16	34
060680712	Z1 -28	50
062401406	Z1 -22	50
062501006	Z2 -9-2-20-3	54
062501406	Z2 -9-1-15-4	52
	Z2 -9-2-17-4	54
062630412	L1 -3	34
	L1 -18	36
	L2 -3	38
	L2 -16	40
	M1 -50	44
	M1 -52	44
	M2 -52	48
062630612	G2 -5-1-4	14
062660412	M1 -32-15	42
	M1 -32-17	42
	M2 -32-15	46
	M2 -32-17	46
062660512	G3 -5-1-10	16
	G4 -5-10	18
	G5 -5-10	20
	L1 -12-2	34
	L2 -12-2	38
062660612	M1 -48-1	44
062670412	G1 -13-1-1	12
	M1 -5	42
	M2 -5	46
062670512	K -25	32
	L1 -5	34
	L2 -5	38
	M1 -6	42
	M2 -6	46
062670612	C -5	4
	M1 -14	42
	M1 -16	42
	M1 -27	42
	M1 -29	42
	M1 -32-7	42
	M1 -41	42
	M2 -14	46
	M2 -16	46
	M2 -27	46
	M2 -29	46
	M2 -32-7	46
	M2 -41	46
062670712	H -1-8	26
	H -1-21	26

CODE	REF.NO.	Page
062670712	L1 -14	34
	L2 -14	38
	M1 -46	44
062670812	M1 -9	42
	M2 -9	46
062671012	H -1-39	26
	G1 -19	12
	G2 -19	14
	G2 -23-2	14
	G3 -17	16
	G3 -21	16
	G4 -17	18
	G4 -21	18
	G5 -17	20
	G5 -21	20
	G6 -17	22
	G6 -21	22
	G7 -17	24
	G7 -21	24
	M1 -7	42
	M1 -20	42
	M2 -7	46
	M2 -20	46
062671412	M1 -48-2	44
	M2 -48	48
062680512	H -1-29	26
	D1 -17	4
	D2 -23	6
062680612	G1 -21	12
	G2 -21-1	14
062680712	E -19	8
	H -5-8-1	26
062680812	E -26	8
	K -19-1	32
062681012	H -5-1	26
	D1 -15	4
	D2 -21	6
	G1 -23	12
	G2 -23-1	14
062710812	E -13	8
	L1 -24	34
	L2 -35	38
062711012	B -7	2
	J -9	30
062711612	E -9	8
062712012	L1 -6	34
	L2 -6	38
062761012	H -5-30	28
071063550	D2 -27	6
072600040	H -1-2	26
072620070	J -2	30
072620180	J -3	30
072630260	B -3	2
	J -6	30
076302850	B -2	2
081003670	H -1-42	26
	K -13	32
081005070	F -14	10
081006070	F -10	10
081007070	K -27	32
081010870	K -10	32
081014670	B -10-3	2
081025570	H -1-18	26

CODE	REF.NO.	Page
100022004	K - 15-2	32
100032004	G1 - 4	12
	G2 - 4	14
	G3 - 4	16
	G4 - 4	18
	G5 - 4	20
	G6 - 4	22
	G7 - 4	24
100058003	L2 - 33-1	38
100064005	L1 - 12-6	34
	L2 - 12-6	38
	L2 - 21-2	38
	M1 - 34	42
	M2 - 34	46
100251001	C - 11-1	4
	C - 11-1	4
	C - 11-2	4
100257010	B - 10-5	2
100260001	K - 11	32
100279109	H - 5-4	26
100366001	K - 12-1	32
100463001	Z1 - 14	50
100645003	L2 - 31	38
100887001	Z1 - 3-2	50
101488001	G-13	55
101491101	G1 - 5-1	12
	G-5	56
101494001	G2 - 13-1	14
	G-13	55
	G-13	56
101497001	G-13	55
	G-13	56
101561001	G-13	56
	G-14	57
101564001	G-14	57
	G-14	59
101572101	Z1 - 2-2	50
101949001	G-13	55
102630001	C - 3	4
102716004	J - 5	30
102921002	D1 - 10	4
	D2 - 16	6
103408002	G1 - 1-1	12
	G2 - 1-1-1	14
	G4 - 1-1	18
	G6 - 1-1	22
104449009	A - 13	2
104547001	B - 10-2	2
105071001	B - 10-7	2
105073001	L2 - 27	38
105091001	D2 - 2	6
105094009	D2 - 6	6
105095001	D2 - 7	6
105096009	D2 - 8	6
105100001	D2 - 9	6
105103001	D1 - 7	4
	D2 - 13	6
105104001	D1 - 8	4
	D2 - 14	6
105105009	D1 - 9	4
	D2 - 15	6
105106001	D1 - 11	4
	D2 - 17	6

CODE	REF.NO.	Page
105113001	H - 1-45	26
105118000	G1 - 5-1-1	12
	G1 - 5-2-1	12
105129001	G1 - 12	12
	G2 - 12	14
	G3 - 12	16
	G4 - 12	18
	G5 - 12	20
	G6 - 12	22
	G7 - 12	24
105130001	G1 - 13-2-1	12
	G1 - 14	12
	G2 - 13-1-1	14
	G2 - 14	14
	G3 - 13	16
	G3 - 14-1-1	16
	G4 - 13	18
	G5 - 13	20
	G6 - 13	22
	G7 - 13	24
105141001	E - 12	8
105144001	E - 15	8
105146001	A - 3	2
105147101	J - 1	30
105150000	J - 4	30
105155001	J - 10	30
105156002	J - 11	30
105173004	G1 - 8	12
	G2 - 8	14
	G3 - 8	16
	G4 - 8	18
	G5 - 8	20
	G6 - 8	22
	G7 - 8	24
105176001	K - 3-1	32
	K - 15-1-1	32
105177001	K - 4	32
105178100	K - 5	32
105179001	K - 6	32
105183001	K - 7-1	32
105184000	K - 7-2	32
105191001	K - 9	32
105193101	K - 15	32
105198000	K - 15-3	32
105200101	K - 16-1	32
105201000	K - 17	32
105215001	H - 1-46	26
105216001	K - 22	32
105217059	K - 23	32
105221001	L1 - 2-1	34
	L1 - 2-2	34
	L2 - 2-1	38
	L2 - 2-2	40
	M1 - 2-1	44
	M1 - 2-2	44
105222001	L1 - 4	34
	L2 - 4	38
105231000	L1 - 7-1-2	34
	L1 - 7-2-2	36
	L2 - 7-1-2	38
	L2 - 7-2-2	40
105233002	L1 - 7-1-4	34
	L1 - 7-2-4	36

CODE	REF.NO.	Page
105233002	L2 - 7-1-4	40
	L2 - 7-2-4	40
105234003	L1 - 7-1-5	34
	L1 - 7-2-5	36
	L2 - 7-1-5	40
	L2 - 7-2-5	40
	L2 - 32	38
105235251	L1 - 8	34
	L2 - 8	38
105236001	L1 - 10	34
	L2 - 10	38
105237002	L1 - 11	34
	L2 - 11	38
105243001	L1 - 12-3	34
	L2 - 12-3	38
105244000	L1 - 12-4	34
	L2 - 12-4	38
105245001	L1 - 12-5	34
	L2 - 12-5	38
105251009	M1 - 8-1	44
	M2 - 8-1	48
105257009	M1 - 18	42
	M2 - 18	46
105260009	M1 - 19	42
	M2 - 19	46
105277001	L2 - 30	38
105280009	M1 - 32-1	42
	M2 - 32-1	46
105281001	M1 - 32-2	42
	M2 - 32-2	46
105284101	M1 - 32-4	42
	M2 - 32-4	46
105285000	M1 - 32-5	42
	M2 - 32-5	46
105287001	M1 - 32-8	42
	M2 - 32-8	46
105288001	M1 - 32-9	42
	M1 - 32-20	42
	M2 - 32-9	46
	M2 - 32-20	46
105296001	M1 - 32-18	42
	M2 - 32-18	46
105300101	M1 - 36	42
	M2 - 36	46
105301001	M1 - 37-1	44
105302001	G-10	56
105303001	G1 - 9-1	12
105304001	M1 - 47-1	44
105333001	D1 - 12	4
	D2 - 18	6
105337001	A - 2	2
105341051	A - 5	2
105344001	Z1 - 2-1	50
105359001	Z1 - 18	50
106062009	Z1 - 15	50
106160101	G1 - 5-2	12
	G-5	56
106170001	G-10	56
106568003	H - 5-17	28
106794001	H - 5-6	26
107153001	C - 2	4
108960002	M1 - 31	42
	M2 - 31	46

CODE	REF.NO.	Page
109153001	H - 1-26	26
109656009	Z1 - 13	50
109657009	Z1 - 16	50
109993001	C - 16	4
110813001	L1 - 7-1-1-3	34
	L1 - 7-2-1-3	34
	L2 - 7-1-1-3	38
	L2 - 7-2-1-3	40
110832009	L1 - 7-1-1-4	34
	L1 - 7-2-1-4	34
	L2 - 7-1-1-4	38
	L2 - 7-2-1-4	40
111024101	C - 8	4
111025001	D1 - 3-1	4
	D2 - 3-1	6
111070109	L1 - 1	34
	L2 - 1	38
111072009	L1 - 17	36
	L2 - 15	40
	M1 - 51	44
	M2 - 51	48
111073001	L1 - 19	36
	L2 - 17	40
	M1 - 3	42
	M1 - 53	44
	M2 - 3	46
	M2 - 53	48
111075059	L1 - 7-1-1-1	34
	L1 - 7-2-1-1	34
	L2 - 7-1-1-1	38
	L2 - 7-2-1-1	40
111076151	L1 - 7-1-3	34
	L1 - 7-2-3	36
	L2 - 7-1-3	40
	L2 - 7-2-3	40
111077001	L1 - 15	34
	L2 - 18	38
111078051	L2 - 20	38
111079001	L2 - 21-1	38
111082051	L2 - 21-5	38
111083001	L1 - 20	34
	L2 - 23	38
111084001	L1 - 22	34
	L2 - 25	38
111089001	L2 - 26	38
111093001	L2 - 29	38
111095009	M1 - 1	42
	M2 - 1	46
111096009	M1 - 4	42
	M2 - 4	46
111097009	M1 - 8-2	44
	M2 - 8-2	48
111105002	G1 - 5-3-3	12
	G3 - 5-1-12	16
	G4 - 5-12	18
	G5 - 5-12	20
111112001	M1 - 32-19	42
	M2 - 32-19	46
111113101	M1 - 39	42
	M2 - 39	46
111114101	M1 - 40	42
	M2 - 40	46
111128022	G5 - 2	20

CODE	REF.NO.	Page
111140001	G1 - 5-2-2	12
111168001	G-14	60
111171001	G-14	57
111174001	G-14	60
111177001	G-14	57
111180001	G-14	60
111183001	G-14	57
111188001	L1 - 21	34
	L2 - 24	38
111189001	L2 - 28	38
111193001	B - 10-6	2
111194001	B - 10-8	2
111443003	G1 - 9-2	12
	G2 - 9	14
	G2 - 21-2	14
	G2 - 21-2	14
	G3 - 10	16
	G3 - 19	16
	G4 - 10	18
	G4 - 19	18
	G5 - 10	20
	G5 - 19	20
	G6 - 10	22
	G7 - 10	24
	G7 - 19	24
111506101	L2 - 21	38
111863001	C - 13	4
112618001	H - 5-9	26
112658001	M1 - 30	42
	M2 - 30	46
113605051	C - 6	4
114483002	Z1 - 6	50
115132002	L2 - 21-4	38
116016001	Z1 - 20	50
116577051	E - 11	8
117437109	Z1 - 12	50
117466000	Z1 - 5	50
117934009	H - 1-12	26
	D1 - 19	4
	D2 - 25	6
122771001	G3 - 14-2-1	16
	G4 - 14-1-1	18
	G5 - 14-1	20
	G6 - 14-1-1	22
	G7 - 14-1	24
122771002	M1 - 32-3	42
	M2 - 32-3	46
122991001	Z1 - 1	50
123006001	C - 12	4
126863001	Z2 - 9-1-3	52
	Z2 - 9-2-3	54
133636009	Z1 - 10	50
138843001	Z2 - 9-1-12	52
	Z2 - 9-2-12	54
140004001	C - 1-2	4
140518001	K - 26	32
140890009	C - 14	4
141099001	H - 5-7	26
142274009	C - 1-1	4
	M1 - 17	42
	M2 - 17	46
142627001	E - 16	8
142721001	Z1 - 3-1	50

CODE	REF.NO.	Page
142747002	G7 - 5-3-2	24
142998101	Z2 - 9-1-6	52
144103009	L1 - 7-1-1-6	34
	L1 - 7-2-1-6	34
	L2 - 7-1-1-6	38
	L2 - 7-2-1-6	40
144104001	L1 - 7-1-1-7	34
	L1 - 7-2-1-7	34
144228001	Z1 - 8	50
144504001	M1 - 24-1	44
	M1 - 24-2	44
	M1 - 56	44
	M2 - 24-1	48
	M2 - 24-2	48
145440001	L1 - 7-1-1-2	34
	L1 - 7-2-1-2	34
	L2 - 7-1-1-2	38
	L2 - 7-2-1-2	40
145446001	L1 - 7-1-1-5	34
	L1 - 7-2-1-5	34
	L2 - 7-1-1-5	38
	L2 - 7-2-1-5	40
145688000	C - 4	4
146354001	M1 - 55	44
146427001	G2 - 1-2-1	14
	G3 - 1-1	16
	G5 - 1-1	20
	G7 - 1-1	24
147291001	M1 - 37-2	44
	M2 - 37	46
147302001	G4 - 14-1	18
	G6 - 14-1	22
	G-14	58
	G-14	59
	G-14	59
147307001	G4 - 7-1-1	18
	G5 - 7-1-1	20
	G6 - 7-1-1	22
	G7 - 7-1-1	24
147865001	D2 - 3-2	6
147867001	G-3	58
147868201	G-5	58
147871001	G1 - 5-3-1	12
	G2 - 5-1-1	14
	G2 - 5-2-1	14
	G3 - 5-1-1	16
	G4 - 5-1	18
	G5 - 5-1	20
147872001	G3 - 5-1-2	16
	G4 - 5-2	18
	G5 - 5-2	20
147875001	G3 - 5-1-6	16
	G4 - 5-6	18
	G5 - 5-6	20
147876001	G3 - 5-1-7	16
	G4 - 5-7	18
	G5 - 5-7	20
147877001	G3 - 5-1-8	16
	G4 - 5-8	18
	G5 - 5-8	20
147878001	G3 - 5-1-9	16
	G4 - 5-9	18
	G5 - 5-9	20

CODE	REF.NO.	Page
147879001	G4 -5-11	18
	G5 -5-11	20
147880001	G4 -7-1-2	18
	G4 -7-2-2	18
	G5 -7-1-2	20
	G5 -7-2-2	20
	G6 -7-1-2	22
	G6 -7-2-2	22
	G7 -7-1-2	24
	G7 -7-2-2	24
147890001	G3 -5-1-4	16
	G4 -5-4	18
	G5 -5-4	20
147932001	G1 -5-3-5	12
	G2 -5-1-3	14
	G2 -5-2-3	14
	G3 -5-1-5	16
	G4 -5-5	18
	G5 -5-5	20
	G6 -5-3	22
	G7 -5-1-3	24
	G7 -5-2-3	24
	G7 -5-3-4	24
148006001	D2 -10	6
148007051	D2 -12	6
148294001	H -1-33	26
148298001	Z1 -23	50
148851001	L2 -7-1-1-7	38
	L2 -7-2-1-7	40
148864001	G-3	58
148865201	G-5	58
148867101	G-7	58
148875001	G3 -9	16
	G5 -9	20
	G7 -9	24
148876001	G1 -17	12
	G2 -17	14
	G3 -15	16
	G4 -15	18
	G5 -15	20
	G6 -15	22
	G7 -15	24
148877100	K -18	32
148927001	G-3	58
148928201	G-5	58
148932101	G-7	58
148936001	G-14	58
	G-14	59
148944001	G-3	58
148945201	G-5	58
148951001	G-14	58
	G-14	59
148971001	G4 -7-1	18
	G-7	58
148973001	G4 -9	18
	G6 -9	22
	G-10	55
	G-10	56
	G-10	56
149011051	L2 -21-3	38
150173003	Z2 -9-1-9	52
	Z2 -9-2-9	54
150174000	Z2 -9-1-7-1	52

CODE	REF.NO.	Page
150174000	Z2 -9-2-7-1	54
150179002	Z2 -9-1-10-1	52
150179002	Z2 -9-2-10-1	54
150180001	Z2 -9-1-1	52
	Z2 -9-2-1	54
150182000	Z2 -9-1-2	52
	Z2 -9-2-2	54
150185009	Z2 -9-1-11	52
	Z2 -9-2-11	54
150188009	Z2 -9-2-13	54
150194009	Z2 -9-2-14	54
150206002	Z2 -9-1-4-1	52
	Z2 -9-2-4-1	54
150608001	H -1-22	26
150611001	H -1-28	26
150612001	H -1-30	26
150613001	H -1-31	26
150614001	H -1-32	26
150641001	H -1-40	26
150659001	E -22	8
150661001	E -24	8
150665001	D1 -3-2	4
	D2 -3-3	6
150666001	G-3	59
150667001	G-3	59
150668101	G-5	59
150670001	G6 -5-1	22
	G7 -5-1-1	24
	G7 -5-3-1	24
150671001	G6 -5-2	22
	G7 -5-1-2	24
	G7 -5-3-3	24
150672101	G7 -5-1	24
	G-5	59
150673001	G6 -7-1	22
	G-7	59
150675101	G-7	59
150679001	H -1-1	26
150682000	H -1-3	26
150683000	H -1-4	26
150684001	H -1-6	26
150686101	H -1-9	26
150687000	H -1-11	26
150688101	H -1-13	26
150690101	H -1-14	26
150693000	H -1-19	26
150695000	H -1-34	26
150696001	H -1-35	26
150697001	A -12	2
	H -1-36	26
150698009	H -1-37	26
150699000	H -1-38	26
150700001	H -1-41	26
150701001	H -1-43	26
150704001	H -5-2	26
150705001	H -5-10	28
150706001	H -5-11	28
150711001	H -5-13	28
150712001	H -5-14	28
150715001	H -5-16	28
150716001	H -5-18	28
150717000	H -5-19	28
150718001	H -5-21	28

CODE	REF.NO.	Page
150719001	H -9-2	28
150720001	H -5-24	28
150721001	H -5-25	28
150722001	H -5-26	28
150723001	H -5-27	28
150725001	H -6	28
150726001	H -7	28
151074009	B -10-4	2
151478001	G-3	59
151479101	G-5	59
151481001	G7 -5-2-1	24
151482001	G7 -5-2-2	24
151483101	G-7	59
151486001	G-3	59
151487101	G7 -5-2	24
	G-5	59
151571001	G3 -5-2-3	16
151572101	G3 -5-1-13	16
	G4 -5-13	18
	G5 -5-13	20
151602002	L1 -9	34
	L2 -9	38
151604001	Z1 -11-1	50
151927001	C -15	4
153675001	K -1-1	32
	K -29-1	32
153787001	G3 -5-2-2	16
153965001	H -5-28	28
154344201	H -9-1	28
155510001	M1 -26-1	44
	M1 -26-2	44
	M1 -58	44
	M2 -26-1	48
	M2 -26-2	48
155558001	E -20	8
156112003	Z2 -9-1-8	52
	Z2 -9-2-8	54
156175001	G-3	59
156179101	G-5	59
156182101	G7 -7-3	24
	G-7	59
156211101	G6 -5-4	22
	G7 -5-1-4	24
	G7 -5-2-4	24
	G7 -5-3-5	24
156792001	G1 -5-1-2	12
	G1 -5-2-3	12
159150009	D1 -20	4
	D1 -21	4
	D2 -26	6
	D2 -28	6
159583001	G-3	57
159584201	G-5	57
159587001	G4 -5-7	18
159588001	G4 -7-2	18
	G-7	57
159590001	G4 -7-2-1	18
	G6 -7-2-1	22
159609001	G4 -14-2	18
	G6 -14-2	22
	G-14	57
	G-14	58
159614001	G-3	58

